

GENERAL ELECTRIC



SCHENECTADY, NEW YORK

AD 692178

MACHINE AUGMENTATION OF HUMAN STRENGTH AND ENDURANCE
HARDIMAN I PROTOTYPE PROJECT

Prepared by

Specialty Materials Handling Products Operation
General Electric Company
Schenectady, New York 12305

July 1, 1969

Supported Jointly by

Engineering Psychology Programs Office
Office of Naval Research
Washington, D. C. 20360

Naval Air Systems Command
Washington, D. C. 20360

Army Mobility Equipment Research and Development Center
Fort Belvoir, Virginia 22060
United States Army Project No. IM62410105072

This document has been approved for public release
and sale; its distribution is unlimited.

ONR Contract Number N00014-66-C0051

Work Unit Number NR 196-049

Best Available Copy

S-69-1116

MACHINE AUGMENTATION OF HUMAN STRENGTH AND ENDURANCE

HARDIMAN I PROTOTYPE PROJECT

Supported Jointly by

Engineering Psychology Programs Office
Office of Naval Research
Washington, D. C. 20360

Naval Air Systems Command
Washington, D. C. 20360

Army Mobility Equipment Research and Development Center
Fort Belvoir, Virginia 22060
United States Army Project No. IM62410105072

Work Unit Number NR 196-049

ONR Contract Number N00014-66-C0051

July 1, 1969

Prepared by

Specialty Materials Handling Products Operation
General Electric Company
Schenectady, New York 12305

This document has been approved for public release and sale; its distribution is unlimited.

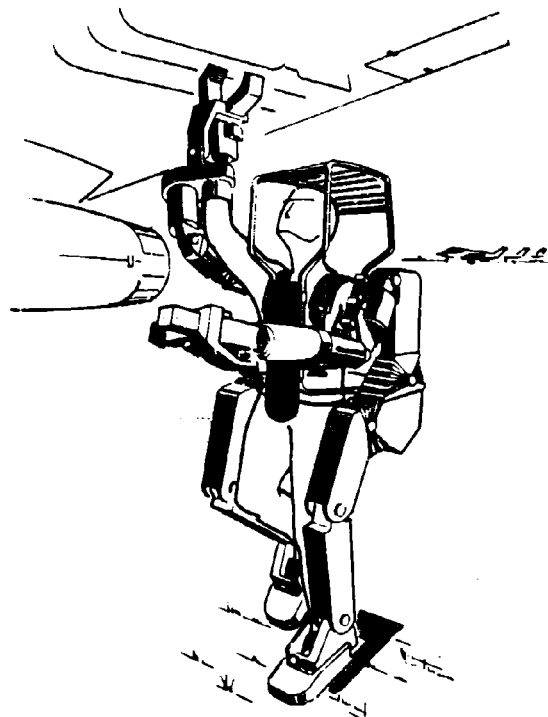

THE POWERED EXOSKELETON PROJECT

The Powered Exoskeleton concept is that of a material handling machine under intimate control of the operator.

"Worn as an outer mechanical garment, the exoskeletal structure will be powered to dramatically amplify the wearer's strength and endurance by a factor of approximately 25 to one, i. e. , when the exoskeleton wearer lifts 25 pounds, he will 'feel' as if he is lifting only one pound. The device will provide him with a set of 'mechanical muscles' that enables him to lift and handle loads in excess of 1000 pounds. The human operator will 'feel' the objects and forces he is working with almost as if he were in direct body and muscle contact. This feature, called force feedback, will provide the operator with sensitive control of the structure and will act as a safeguard against the application of excessive force.

"The exoskeleton, called 'Hardiman,' mimics the movements of its wearer, presenting a literal union of man and machine. Thus, the human's flexibility, intellect, and versatility are combined with the machine's strength and endurance."*

* Naval Research Reviews, July 1967

FOREWORD

At this time, the conceptual design and system definition phases of the Hardiman I Program have been completed.

A prototype having the capability to implement the powered exoskeleton concept has been defined and reduced to engineering drawings suitable for part fabrication and assembly.

One arm assembly has been completed and is undergoing check-out of its servo systems. This was preceded by tests of simulated individual joints and of a partial leg assembly consisting of three joints.

The next major step in the program will be fabrication and assembly of the complete leg and girdle system to demonstrate the walking capability of the Hardiman I prototype.

Part I of this report contains information giving a summary of the overall program.

Part II contains technical data with specific details relating to mechanical design and servo system work.

ACKNOWLEDGMENT

The Government scientific officers and project monitors who have directed this program and provided constructive guidance during the period covered by this report are:

Dr. M. J. Farr and Dr. J. W. Miller
Office of Naval Research
Engineering Psychology Programs
Washington, D. C. 20360

Mr. D. P. Kane
U. S. Army Mobility Equipment
Research and Development Center
Fort Belvoir, Virginia 22060

We would like to thank those mentioned below for their interest and encouragement to this program.

Mr. G. J. Geyer
Naval Air Systems Command
Code Air-5344
Washington, D. C. 20360

Mr. C. Emberger
Naval Supply Systems Command
Code 0631F
Washington, D. C. 02360

TABLE OF CONTENTS

	<u>Page</u>
The Powered Exoskeleton Project	i
Foreword	ii
Acknowledgment	iii
List of Illustrations	v

PART I -- SUMMARY

Section:

1. Introduction	1-2
2. Program History	2-1
3. Evaluation of Program Results	3-1
4. Planned Program Competition	4-1

PART II -- TECHNICAL INFORMATION

Section:

5. Mechanical Design	5-1
6. Arm Servo Design Summary	6-1

LIST OF ILLUSTRATIONS

<u>Figure No.</u>	<u>Title</u>	<u>Page</u>
1	Hardiman I	vi
2	Exoskeletal Harness for Lower Extremities	2-2
3	Exoskeletal Harness for Arm Joints	2-3
4	Exoskeletal Mockup-Arm and Leg Combined	2-4
5	Simulated Exoskeleton Joint Test	2-5
6	Exoskeleton Input Mechanism (Tickler Assembly)	2-7
7	Leg Assembly (Partial) View from Master Side	2-8
8	Leg Assembly (Partial) Rear View	2-9
9	Slave Hand Parts	2-10
10	Master Hand Parts	2-11
11	Hand Assembly	2-12
12	Hand Assembly - Handling 200 lb. Load	2-13
13	Slave Upper Arm and Back Links	2-14
14	Slave Arm Assembly - Front View	2-15
15	Slave Arm Assembly - View from Master Side	2-16
16	Arm Assembly - Master and Slave	2-18
17	Arm Assembly - Operator's Position	2-19
17a.	Arm Assembly after Wiring and Plumbing	2-20
17b.	Arm Assembly in Elevated Position	2-21
18	Angular Excursions of Joints	5-8
19	Foot	5-9
20	Foot Tickler System	5-10
21	Ankle Inversion Housing	5-11
22	Slave Leg	5-12
23	Slave Leg Sections	5-13
24	Master Leg and Ticklers	5-14
25	Girdle	5-15
26	Master Girdle and Hip Flex Tickler	5-16
27	Master Girdle and Hip AB/AD Tickler	5-17
28	Slave Girdle	5-18
29	Slave Girdle - Master AB/AD	5-19
30	Back Link Slave	5-20
31	Back Link Stop Valve Manifold Assembly	5-21
32	Master Back Link	5-22

LIST OF ILLUSTRATIONS

(continued)

<u>Figure No.</u>	<u>Title</u>	<u>Page</u>
33	Upper Arm Assembly	5-23
34	Upper Arm Master	5-24
35	Forearm and Hand-Top View	5-25
36	Forearm and Hand-Side View	5-26
37	Master Forearm and Hand	5-27
38	Single Joint Pictorial Schematic	6-2
39	Signal Flow Diagram	6-9
40	Reduced Signal Flow Diagram	6-13
41	Wrist Flex Outer Loop-II Master and Slave Floating	6-18
42	Wrist Flex Inner Loop-I Master and Slave Floating	6-19
43	Wrist Flex Outer Loop-II Slave Grounded	6-20
44	Wrist Flex Inner Loop-I Slave Grounded	6-21

PART I

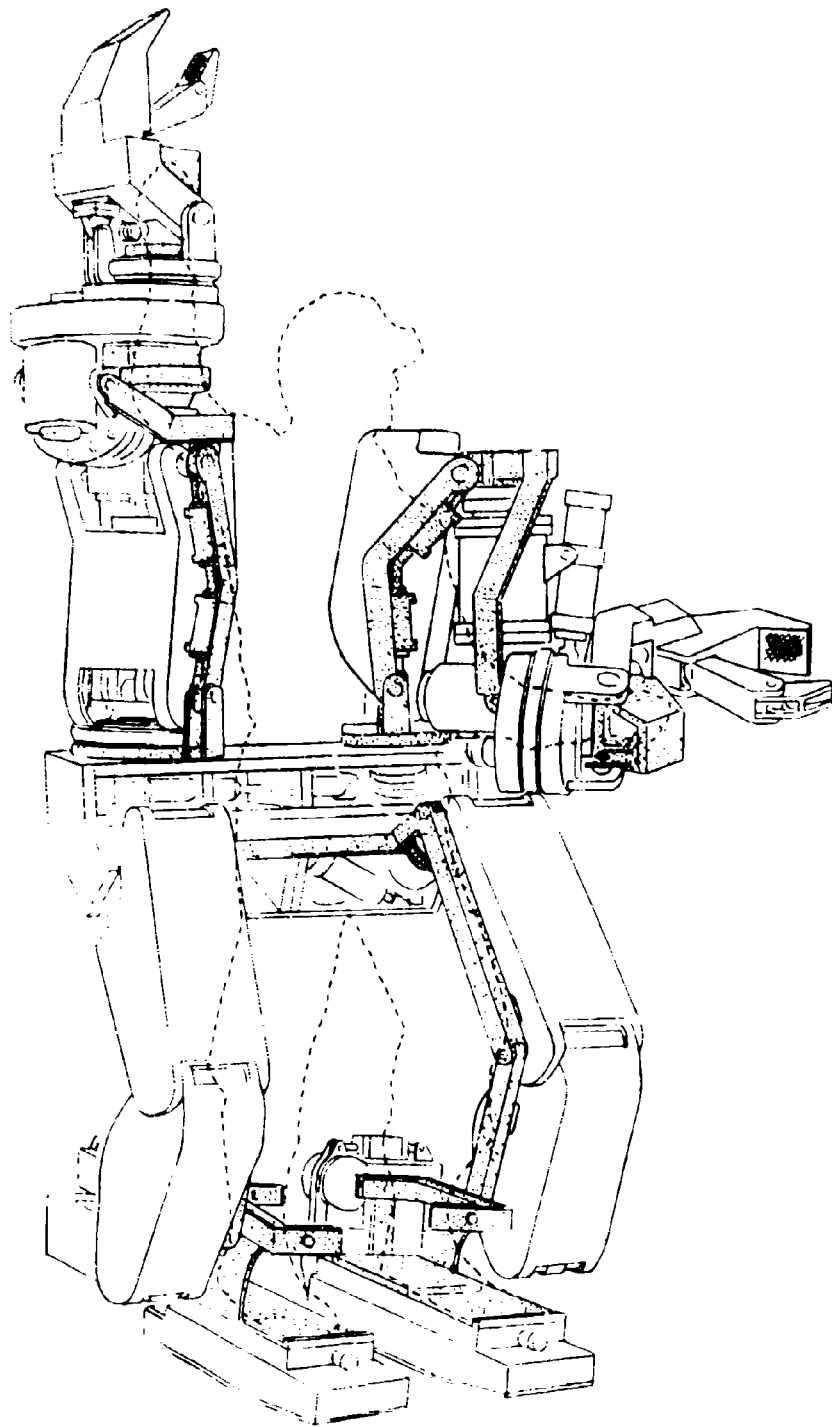

Figure 1. Hardiman I

SECTION 1

INTRODUCTION

The research contract for the development of Hardiman I was initiated as a joint Army-Navy program in November 1965.

The goal of this program is to develop and demonstrate the potential of a powered exoskeleton. This is a powered, jointed, load bearing structure designed to be worn by man and augment his strength and endurance. While wearing the device, an operator will be able to lift up to 1500 pounds as high as 6 feet. He will also be able to carry such a load at least 25 feet in 10 seconds at any height up to 6 feet. Typical applications for the Hardiman I will include loading and unloading cargo from vehicle to ground and vice versa, stacking and moving cargo from place to place, and similar associated tasks. The Hardiman I will be designed so that the wearer can walk, bend, turn, etc., with minimum restraint.

The exoskeleton design concept is shown pictorially in Figure 1. Design layouts giving details of the design are included in Section 5.

The exoskeleton system is a master-slave device. That is, there are two complete "skeletons" -- the exoskeleton proper or slave, which carries the working load, and a master skeleton which is attached to the operator. Each joint of the exoskeleton has a duplicate on the master. The master and slave are geometrically superposed so that corresponding joint axes are approximately collinear.

Since the operator is attached to the master skeleton at appropriate places, he can cause the slave to assume desired postures and hand positions by moving the master. The bilateral servos reflect the working forces of the slave to the operator, reduced by a factor of 25, so that he can sense the operation of the machine as it works.

The structure is supported on two legs terminating in feet. These legs are connected together at the hips by a transverse member (the girdle) -- the only tie between the left and right links. The arms originate at the girdle and pass through a number of links to the hands.

The operator stands inside this structure, to a large extent surrounded and protected by it. Just below the elbow, the operator's arm, the master, and the slave become concentric. There are several advantages to this: the controls are simplified, human factors correspondence is improved by having the slave hand in axial line with the operator's hand, and the operator's hand is protected by being inside the slave housing.

Theoretically no fixed connections other than the servo-control connections are needed between the master and the slave. However, from a practical standpoint, it is recognized that small errors in motion between the master and the slave would soon accumulate to cause an untenable displacement. To prevent the buildup of small master-slave errors, the slave and master feet are fastened together in such a way as to allow control, but prevent master to slave displacement. Reflected forces in the master are generated by separate cylinders that are connected in parallel with the main actuator cylinders of the slave.

In the first laboratory prototype, electrical and hydraulic power will be supplied through an umbilical connection. Future versions may incorporate a self-contained power supply.

Since the man and machine must be so intimately coordinated in this device, the human factors related to the man-machine interface and control system play a crucial role in its design. Early in the program, it was found that much of the human factors data that might have been applied was not available in forms readily applicable to this concept. The required information was developed from existing sources and augmented by laboratory studies using mockups simulating possible configurations of joint designs. It is apparent that the operation and test of the Hardiman I prototype will in itself generate and greatly clarify human factors data in the area of walking anthropomorphic machines and other man-augmentation devices.

SECTION 2

PROGRAM HISTORY

The initial research efforts on the Hardiman I program covered detailed studies of human factors related to man augmentation, particularly in achieving a reasonable compromise between man's capability and feasible mechanical design and servo system requirements.

Passive models such as those shown in Figures 2, 3, and 4 were used to determine the extent of articulation required to permit natural motions on the part of the operator in performing tasks. The number of joints, their relative orientation, and the ranges of individual joint motion were established. A compromise was arrived at based on adaptability to operators ranging from the 5th to the 95th percentile.

Other major areas of the early study phase were machine design, system analysis and servo studies through the use of computer simulation, mockups, laboratory tests and engineering layouts.

By January 1968, the layouts of the mechanical system for the Hardiman I had been successfully completed, demonstrating that the design of such a man-augmentation device is feasible. Specific packaging problems related to compressing the mechanism required for thirty powered joints into the confined space dictated by the man-machine interface were solved and reduced to practical hardware designs.

Only the final design of the servo system remained unsolved. Development of a purely mechanical-hydraulic bilateral servo had not progressed as well as had been expected.

Even though this particular art had been considerably advanced, and servos of this type had been made to perform successfully in the walking truck (Quadruped Transporter Contract #DA 20-113-AMC-09225(T)) they could not be made to satisfy the more stringent requirements of Hardiman I.

The key development problem was the stabilizing of three or more cascaded, high performance servos.

Early in 1968, a special interim study was performed, and the conclusions presented in a formal report (G.E. report S-67-1011 "Special Interim Study" dated 19 April 1968). The conclusions reached in this study were that a conversion from mechanical-hydraulic to electro-hydraulic servos was necessary to achieve the desired performance within the existing state of the art.

This report was soon followed by G.E. report S-68-1081 "Special Technical Report on Joints in Series" dated 10 June 1968, which established a design guide for the solution of the servo system problem.

During 1968, two servo test programs were carried out under G.E.'s self-funded R&D activity which simulated typical Hardiman leg and arm joints and confirmed the analysis of single joint servo performance. (See Figure 5)



Figure 2. Exoskeletal Harness for Lower Extremities

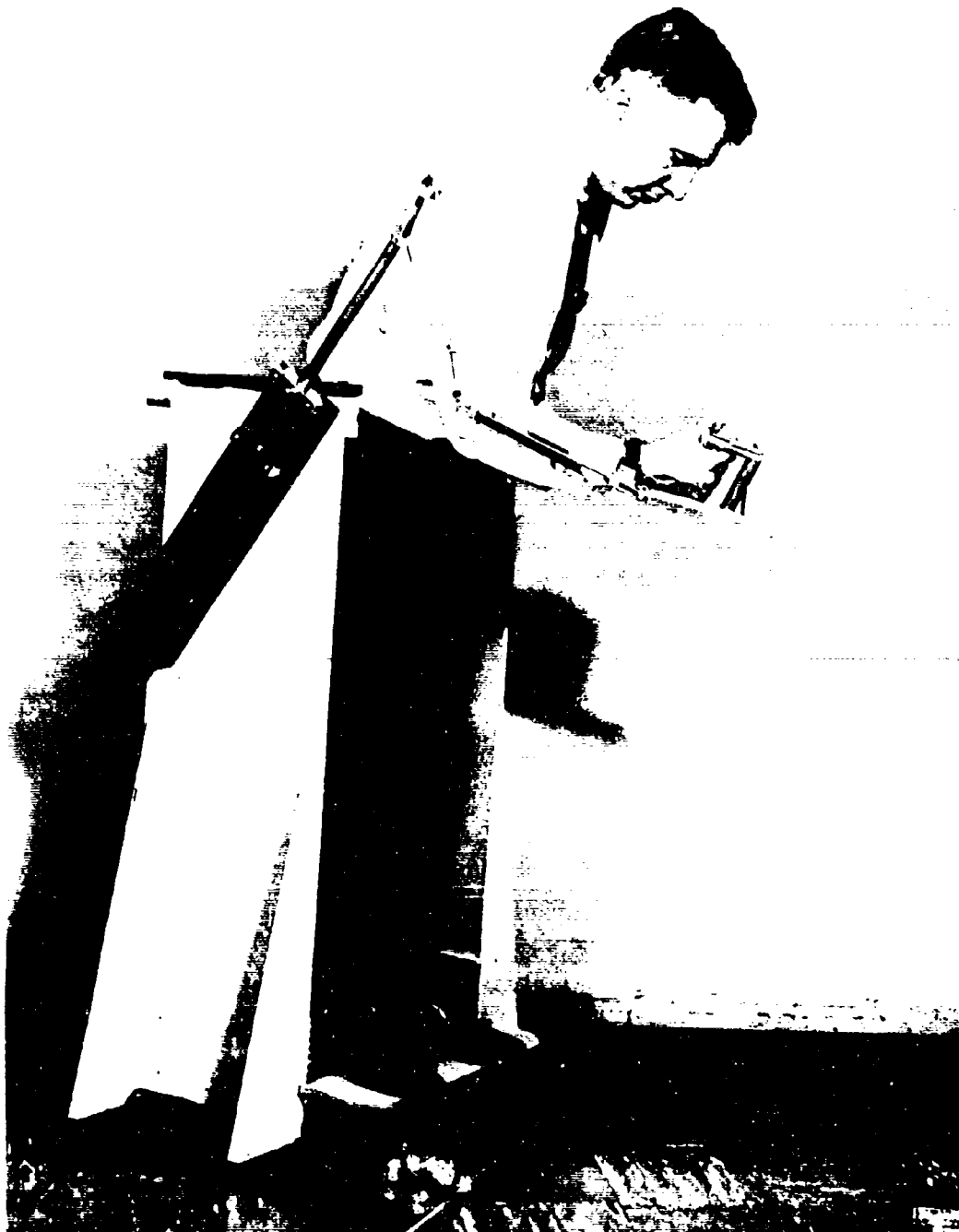

Figure 3. Exoskeletal Harness for Arm Joints



Figure 4. Exoskeletal Mockup - Arm and Leg Combined



Figure 5. Simulated Exoskeleton Joint Test

To make these tests truly representative of the performance requirement, actual Hardiman I hardware such as the servo input mechanism and electronics were used in conjunction with laboratory facilities which simulated the load inertia. (See Figure 6)

The leg and girdle system was completely redesigned for the electrohydraulic conversion by September 1968. Meanwhile, an assembly of three leg joints was built and operated to further confirm the theoretical solution to the joints in series problem. (See Figures 7 and 8)

In September 1968, emphasis was placed on completion of an entire arm, rather than on completion of the leg and girdle system as originally planned. Redesign of the arm system for the electrohydraulic conversion was started. At the same time, parts for the hand assembly (which was unaffected by the redesign) were released for fabrication. (See Figures 9 and 10)

Additional drawings were released sequentially as the redesign progressed in the interest of accelerating completion of the first major functional assembly capable of demonstrating the man-machine load interface.

A subassembly of the hand and wrist was tested in March of 1969 and covered in bi-monthly technical reports. (See Figures 11 and 12)

A full program of testing has been completed on the wrist flex, thumb flex, and thumb tip joints. During this test program, a 400 lb. load was lifted through the full excursion of the wrist flex joint. The force level reflected to the operator was more than adequate to sense the gravitational and inertia loads, yet it was not overpowering or fatiguing.

The force sensitivity, dynamic response and stability exhibited in the wrist flex joint were satisfactory. The slew error and compliance both measured at less than 2% were well within the design specifications of 3 percent.

The remainder of the first arm has since been assembled and tests are now in progress.

Figure 13 shows the slave or structural members of the upper arm and back joints to which the hand assembly is attached.

Figure 14 is a front view of the slave structure. The hand and wrist flex joints are clearly shown in the foreground. The entire hand and wrist flex sub-assembly rotates in the large cylindrical housing in the center of the picture to provide the forearm rotate function. This is the point at which the master becomes co-axial with the slave. Subsequent figures show the master in position inside the slave structure of this joint. The linear actuator at the upper right operates the elbow flex slave joint. The trunnions on the body of this actuator are mounted to the housing of the upper arm rotate actuator. The shoulder flex pivot is barely visible at the top center of the photograph.

Figure 15 shows a view of the slave assembly from the side which will face the operator. The large boxlike structural member in the center of the picture is the back link. At its lower end is the back flex pivot which attaches the back link to the test fixture. The shoulder flex pivot is at the upper right of the back link. The linear hydraulic actuators which operate the back flex and shoulder flex joints are inside the back link structure.



Figure 6. Exoskeleton Input Mechanism (Tickler Assembly)

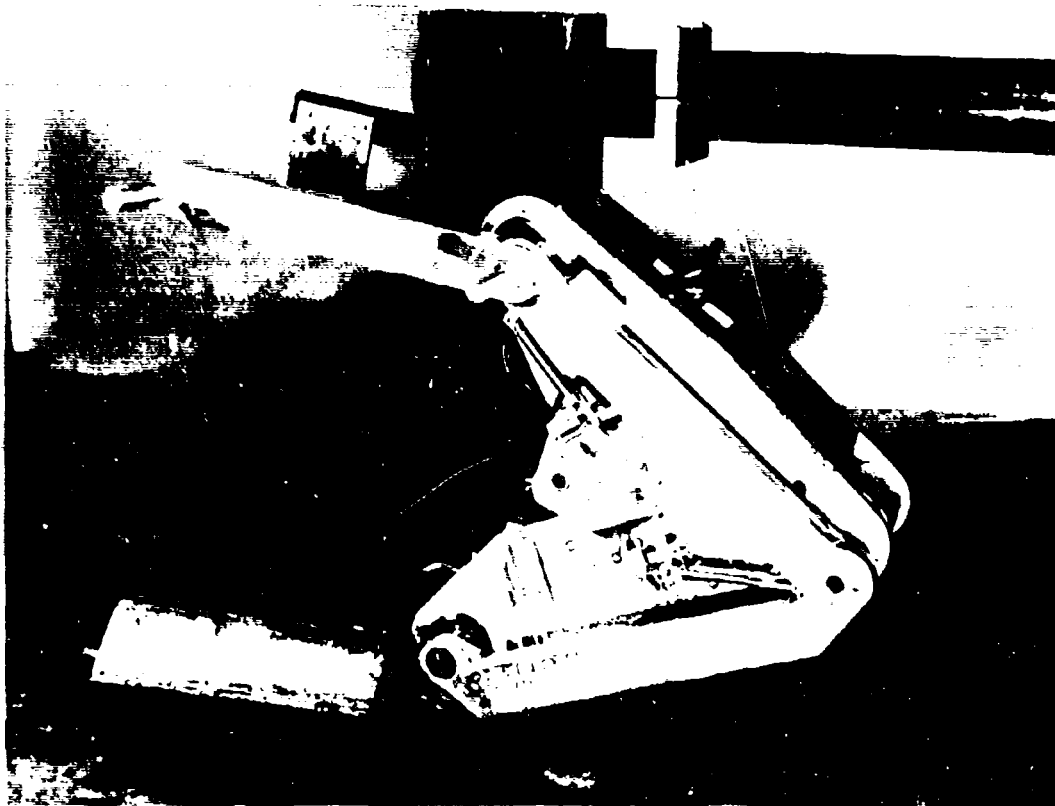

Figure 7. Leg Assembly (Partial) - View from Master Side

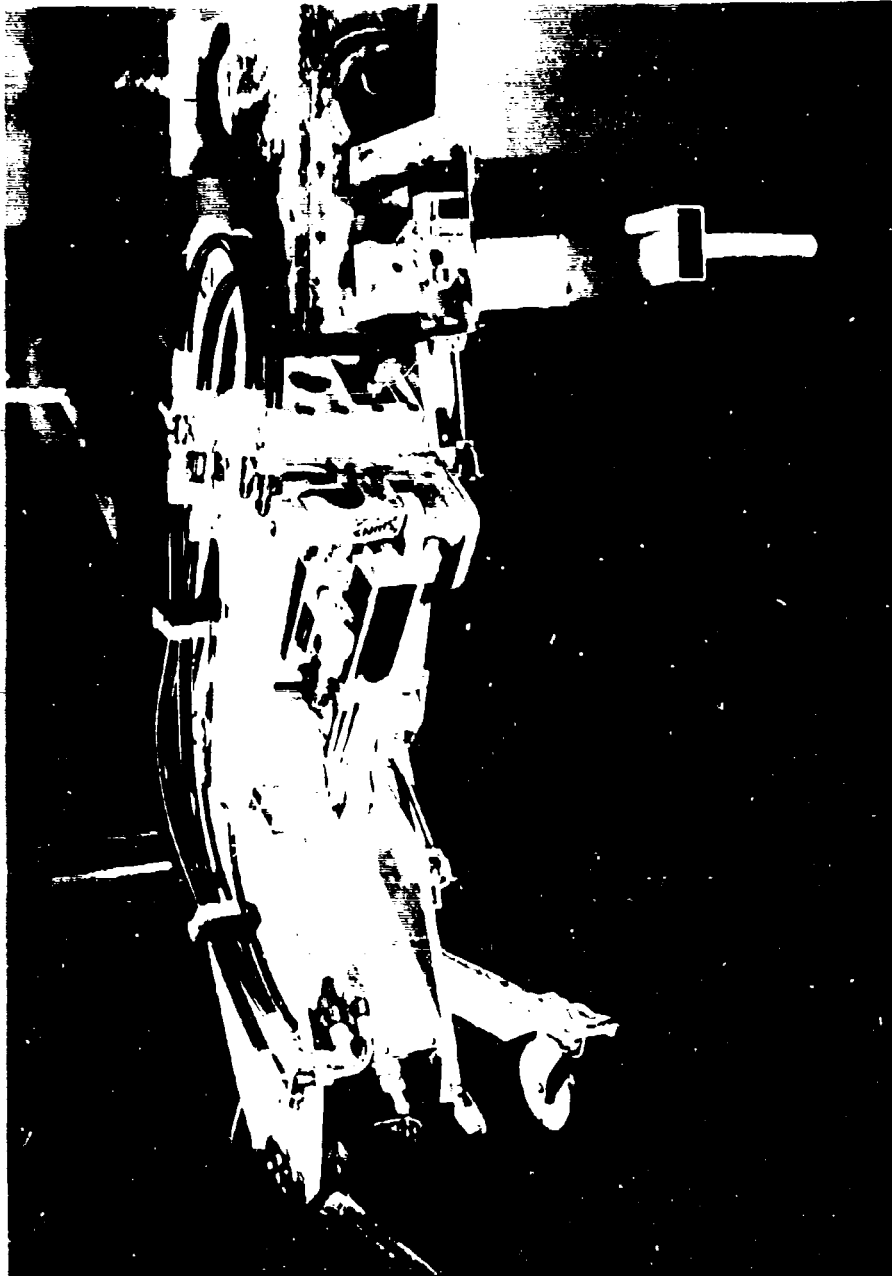

Figure 3. Leg Assembly (Partial) - Rear View

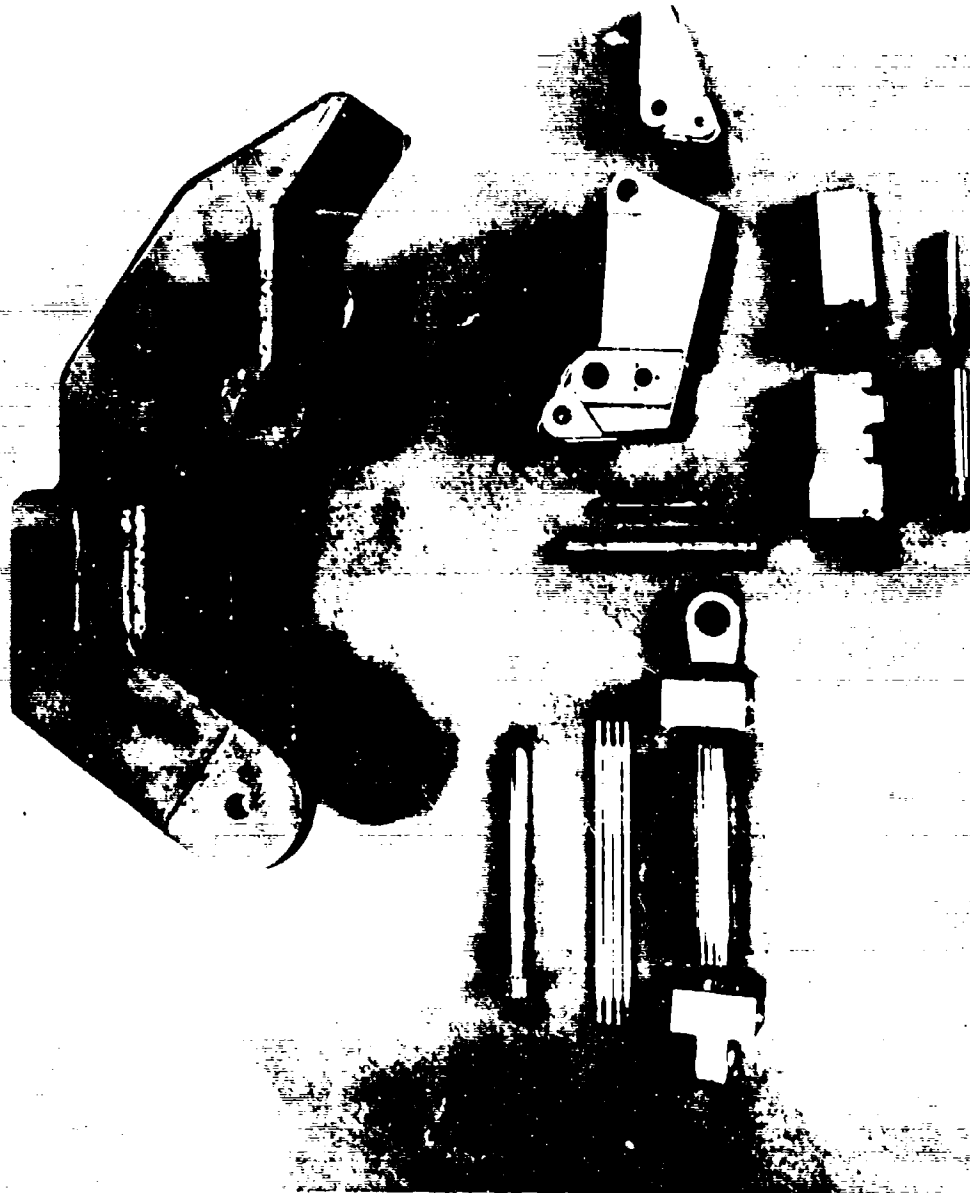

Figure 9. Slave Hand Parts

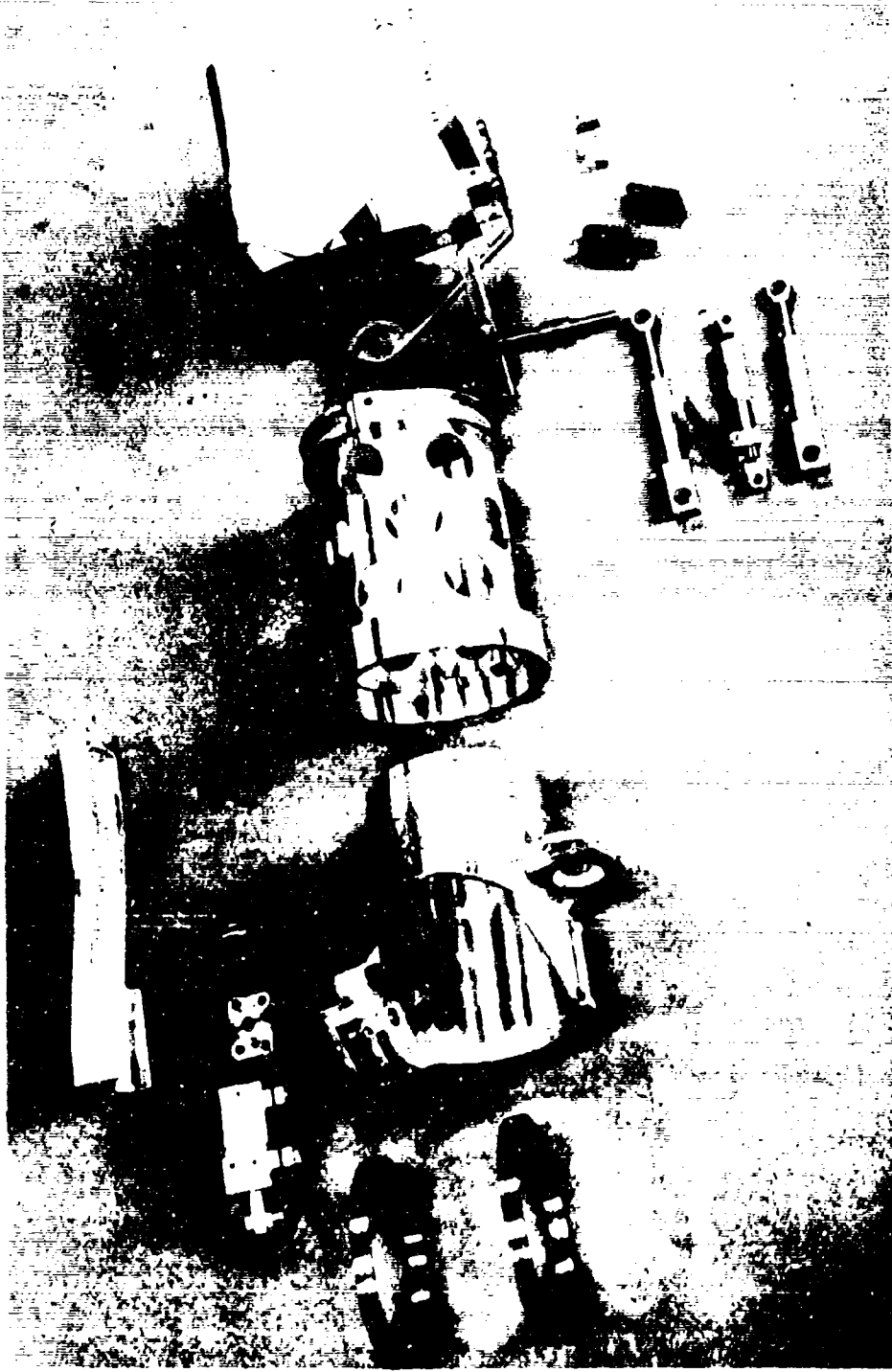

Figure 10. Master Hand Parts

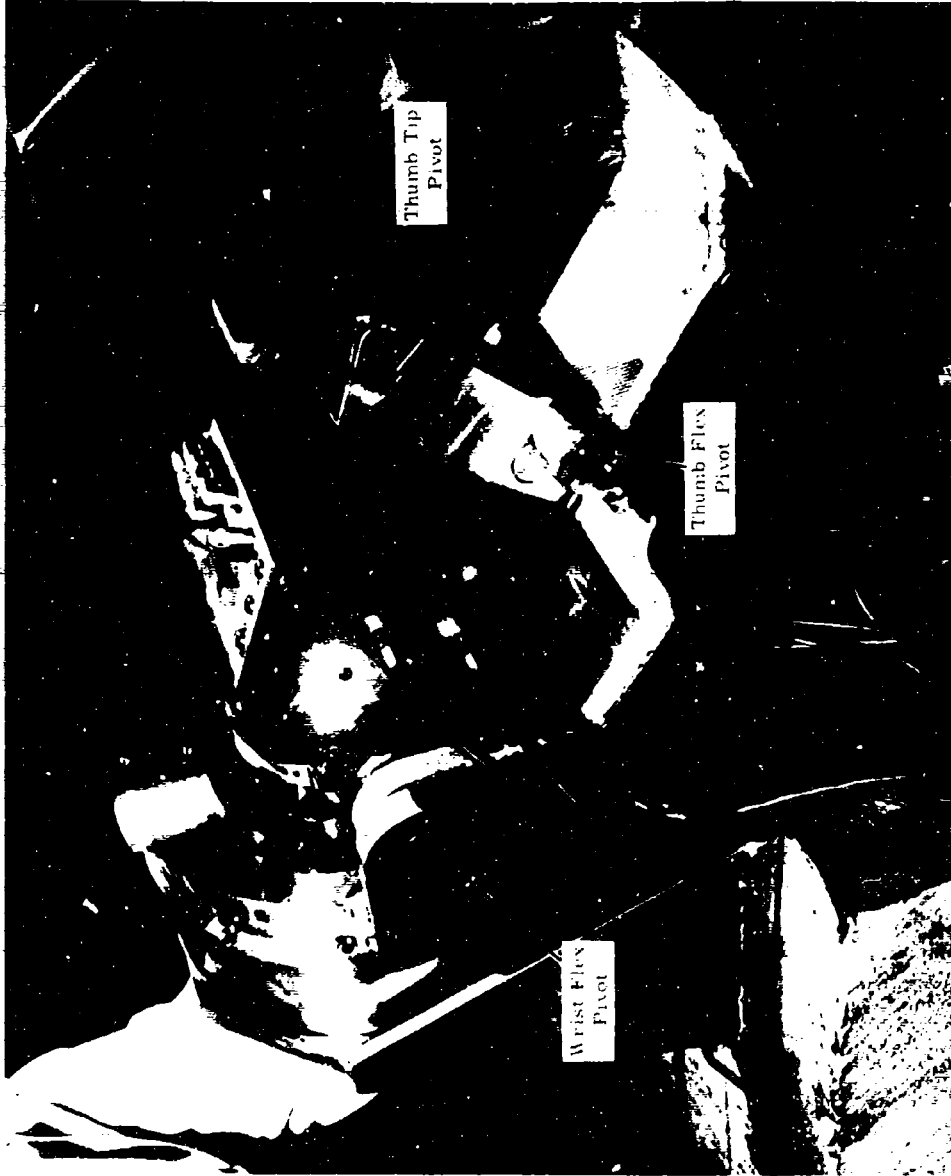

Figure 11. Hand Assembly



Figure 12. Hand Assembly - Handling 200 Pound Load

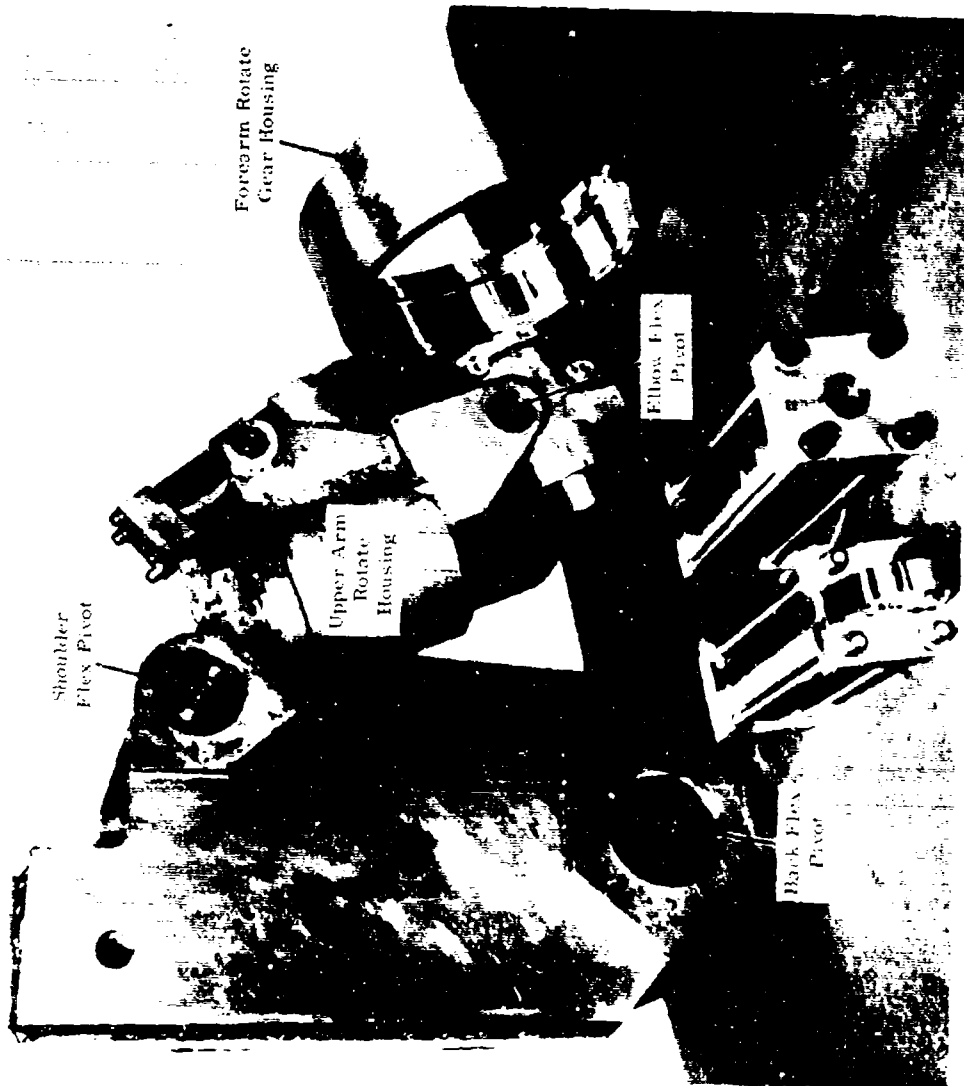

Figure 13. Slave Upper Arm and Back Links



Figure 14. Slave Arm Assembly - Front View

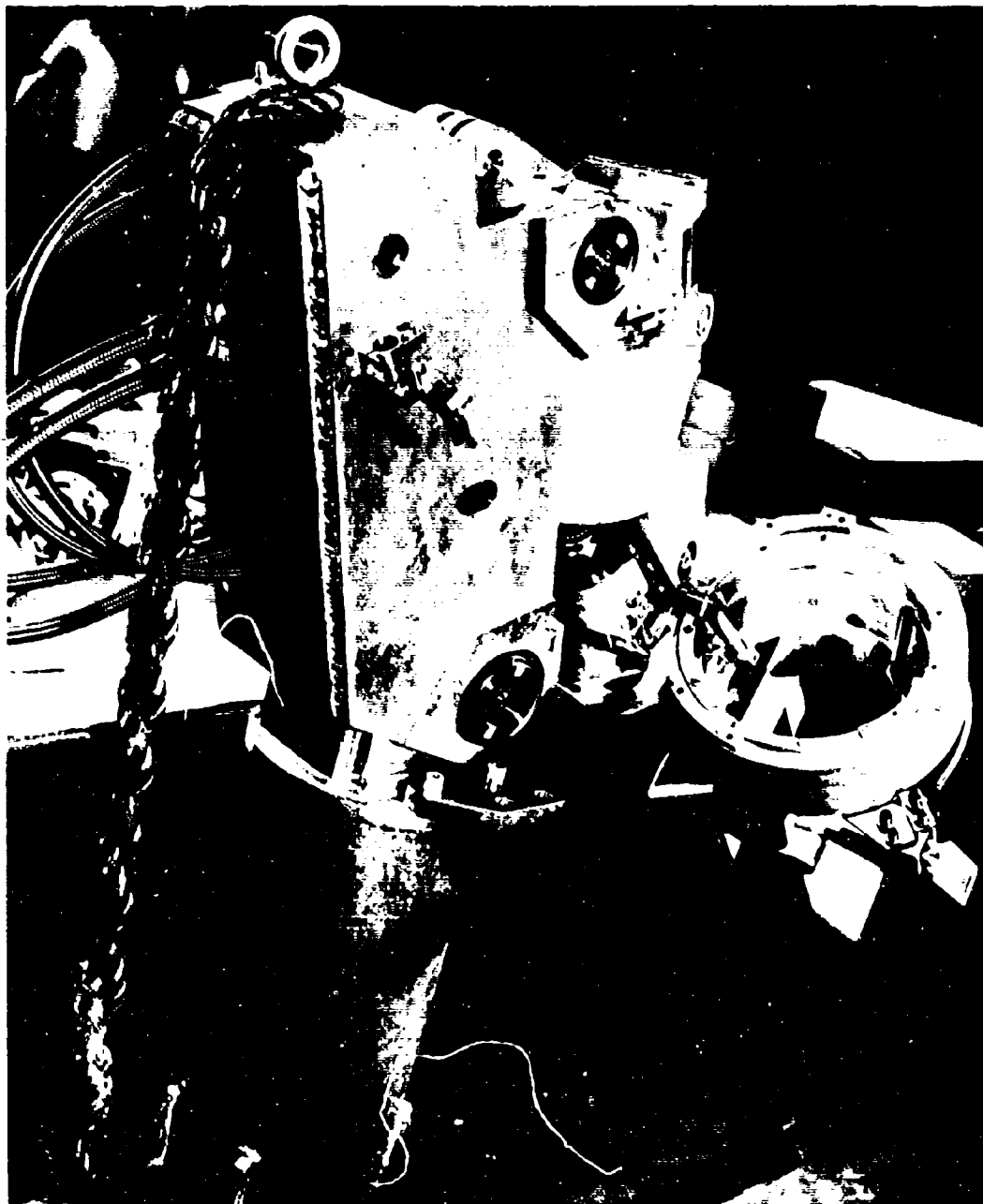

Figure 15. Slave Arm Assembly - View from Master Side

The small mechanism attached to the broad side of the back link is the "tickler" which detects positional errors between the master and slave back links. Transducers mounted in the "tickler" will produce signals to actuate the servo valve controlling this joint. Another "tickler" can be seen on the back side of the forearm rotate housing. The arm master assembly will be bolted to the mounting plate below the back flex pivot.

Figure 16 shows the complete assembly with the master in place. The boxlike assembly being completed by the model maker is the master hand. It contains the hand controls for the thumb, and thumb tip joints. Movement of this assembly around the wrist flex pivot will cause the slave wrist to follow it. The master forearm rotate member is the cylindrical sleeve (perforated at the lower end) which passes through the forearm rotate slave housing. The rectangular structure, supported by two hose lines at the upper center of the photograph, is the upper arm master.

Figure 17 shows the position of the operator's arm relative to the structure. The operator's hand is on the handgrip inside the boxlike master hand. The operator's forearm passes through the slave structure at the forearm rotate joint. The maximum radial clearance between master and slave at this point is one inch. Therefore, the accumulated compliance of the back flex, shoulder flex, upper arm rotate, and elbow flex joints cannot exceed one inch under full load.

Figure 17a. is a view of the arm assembly with hydraulic hoses and electrical wiring in place. The complex array of hoses required to supply the master and slave actuators have been arranged so as not to restrict the operator's motions or cause erroneous force inputs to the master.

Figure 17b. shows the arm in an elevated position.

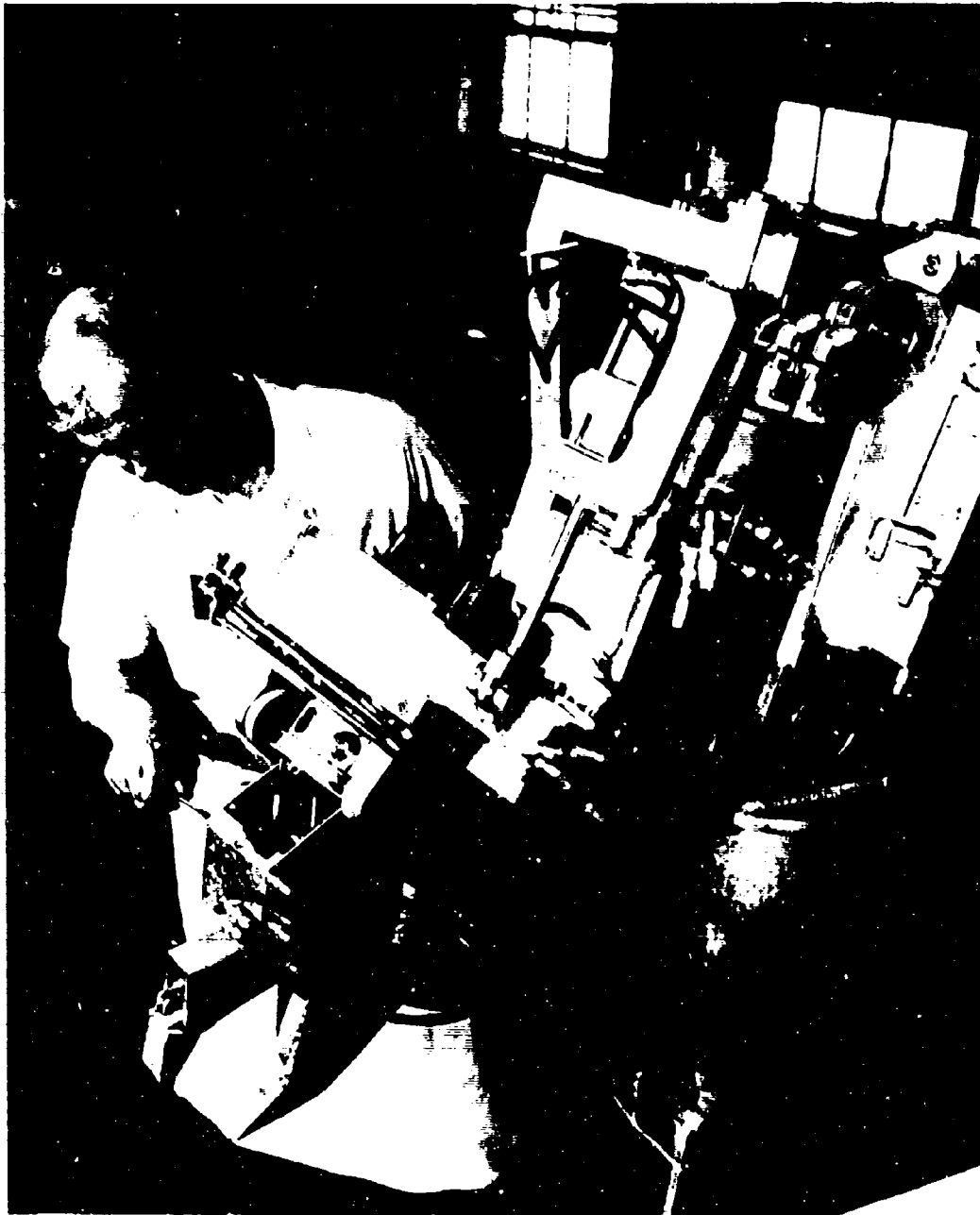

Figure 16. Arm Assembly - Master and Slave



Figure 17. Arm Assembly - Operator's Position

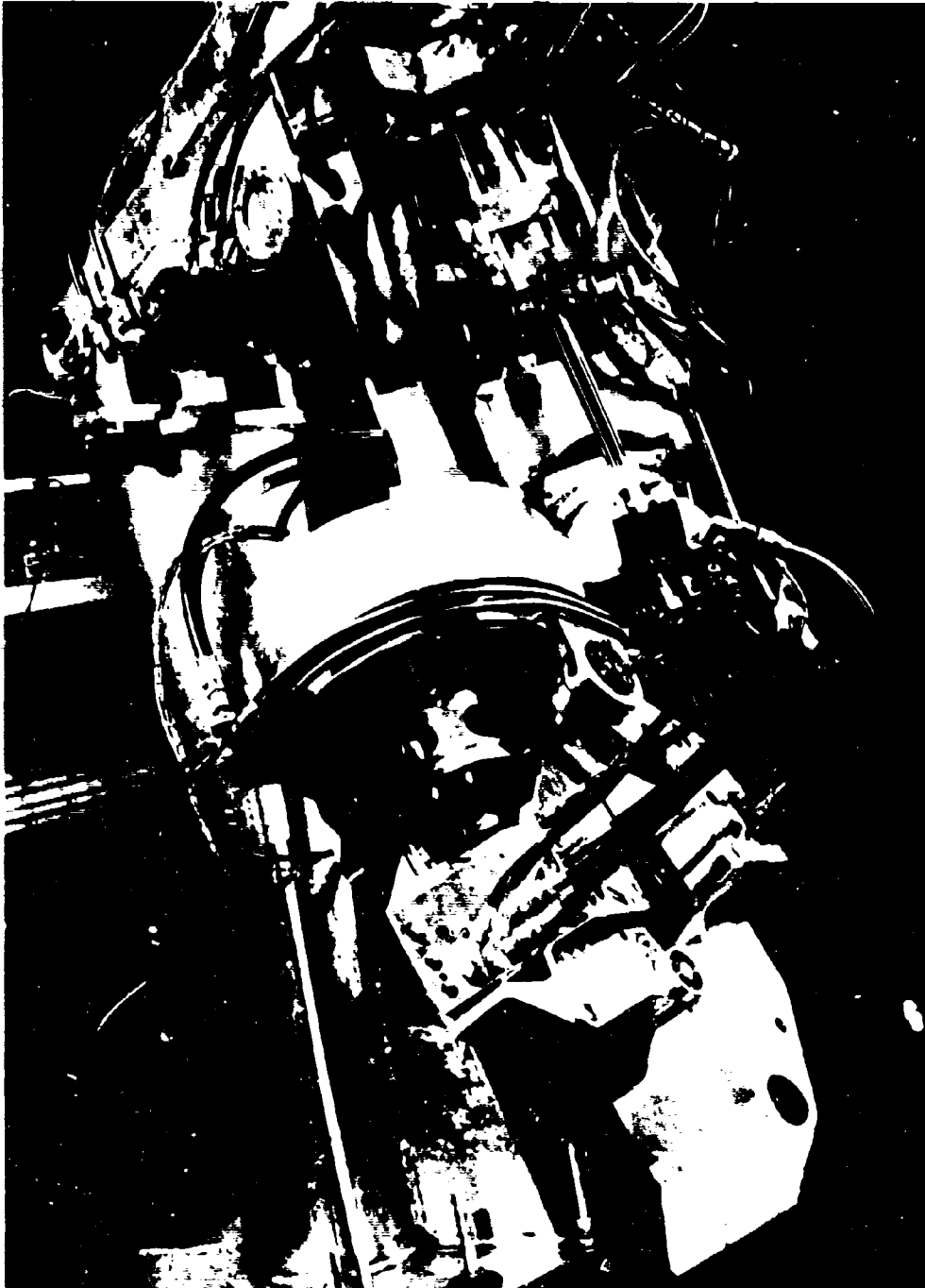

Figure 17A. Arm Assembly After Wiring and Plumbing



Figure 17B. Arm Assembly in Elevated Position

SECTION 3

EVALUATION OF PROGRAM RESULTS

The Hardiman I program has produced significant advances in the technologies related to man-augmentation systems. These advances, in fact, were essential to the implementation of the Hardiman concept. Many of the innovations produced are beneficial to other related applications where servo technology, mechanism cybernetics, and human factors play an important part.

The first implementation of an advanced concept must often be a compromise between what is desired and what is attainable within the bounds of current technology. Such has certainly been the case on the Hardiman I program.

The human body is endowed with so many degrees of freedom that a man-augmentation machine with the same features would require complexity far beyond the limits of practical mechanical design. The present Hardiman design provides adequate freedom and dexterity to perform the basic tasks involved in lifting, manipulating and transporting loads of up to 1500 lbs. The joint configurations arrived at were based on laboratory studies of human factors using passive models in which various joints were locked or unlocked, providing varying degrees of freedom.

The first master-slave configurations were based on ideal relationships for control. The first concept proposed was one utilizing master and slave "skeletons" which were virtually independent of each other. That is to say, there were no attachments between master and slave other than the linkages producing error signals for position control.

Bilateral control with force feedback was to be used throughout the entire master from hand to foot.

This concept was rendered impractical by the limitations of available servo technology. Even with the assumption that significant gains in servo performance were attainable, accumulated desynchronization between master and slave rendered mechanical design and man-machine correspondence impractical.

The present concept, in which the master is split (with the arms and legs of the master anchored to the slave structure at the girdle) evolved from a continuing study of matching man, machine and control system.

Although they have been discarded for this program, the first and intermediate concepts should not be entirely abandoned or considered invalid. They still represent valuable knowledge and planning for man-augmentation devices. It is certainly reasonable to expect that future technological development will provide practical means of implementing concepts which are not now feasible.

With the present control concept, it can be shown analytically that the use of bilateral servos in the leg system would produce false force signals to the operator at the girdle attachment when a load is placed in the hands. For this reason, the servos in the leg system are unilateral or non-force reflecting.

When a load is placed in the slave hands, the operator feels a reflected force in his own hands. The effect of this force carries through the operator's body and gives him a normal set of foot forces which are related to his own center of gravity. By reacting to these forces, he will make motions to achieve balance, which the machine will follow. The force pattern has been verified by laboratory tests.

We are confident that the Hardiman prototype will be a dexterous, versatile device capable of the performance required for implementing the concept and studying the man-machine relationship.

Although the accomplishments cited below are primarily related to servo development and mechanical design, the basic achievement of the program has been to provide means of implementing the man-machine communication through a natural feel of forces being applied.

Early servo development work within the General Electric Company led to the reduction to practice of bilateral servo systems utilizing a single hydraulic valve and actuator for each joint with simple mechanical error linkages between master and slave. This system had the highly desirable features of simplicity and inherent reliability. It also gave high fidelity in force reflection since the same actuator provided slave and master forces through a load sharing linkage.

As attempts were made to incorporate this system in the Hardiman I prototype design, it became evident that such a system could be stabilized only at relatively low gain values.

Since the Powered Exoskeleton Project and the Quadruped Transporter required high gain and low compliance, new system approaches were needed.

A servo development team attacked the problems common to both of these major programs. A velocity compensation network was developed using only mechanical and hydraulic components which improved the margin of stability of the system.

A servo system was devised which employed a velocity compensated valve as the first control stage. Hydraulic pressure signals from this valve operated two repeater valves controlling separate slave and master actuators. Although the complexity of the system had been increased, and the force communication between master and slave became less direct, the basic advantages of the hydromechanical system had been retained. This system was tested in the laboratory and successfully used on the Quadruped Transporter. It did not, however, meet the more exacting performance requirements of Hardiman I.

At this point, it became necessary to convert Hardiman from a purely hydro-mechanical servo system to an electrohydraulic system. The electrohydraulic system permitted the more complex compensation networks required for stability to be implemented electronically within the present state of the art.

The electrohydraulic system finally developed, however, has realized many of the early goals set. Compliance, slew error and other servo performance parameters are well within the design limits established for the Hardiman application. Only one servo valve is required for each joint, as had been originally intended. The master and slave actuators are directly coupled hydraulically. This direct coupling improves force feedback fidelity, especially in transmitting the high frequency vibration associated with touching an object. Although the coupling is hydraulic rather than mechanical, and a second actuator is required, the system achieves the intent of the direct mechanical coupling of the originally intended system.

While the electrohydraulic system has added complexity in the form of position transducers, velocity transducers and amplifiers, the hydraulic and mechanical elements which affect the man-machine communication of forces and position have been restored to relative simplicity.

This single valve, electrohydraulic, bilateral servo system represents a significant accomplishment in servo development which not only makes the Hardiman concept possible, but also makes possible the implementation of many related man-augmentation systems requiring high performance combined with realistic "feel" of the task being performed.

The double tickler system developed for the Hardiman I leg system (and described in detail in previous technical reports) is also a significant accomplishment. The "tickler" system which is used throughout the Hardiman I servo system measures linear displacement between corresponding points on master and slave links. This results in less accumulated error than would result if the more conventional method of measuring angular displacement of each master and slave joint were used. The low compliance error requirements of the Hardiman make the "tickler" method ideal from a performance point of view.

The tickler system, however, is not symmetrical and is inherently "one ended." In the arm system, this presents no problem since all arm movements are initiated by moving the hands or some joints beyond the girdle connection. In the leg system, control may be from either the foot or the girdle, depending whether the foot is on the ground or in the air. The "double tickler" system provides a double set of controls plus a switching system that senses when a foot is grounded. Control is automatically shifted from the foot end to the girdle end of the leg as required.

The development of the "double tickler" system was also a vital factor in developing a feasible method of implementing the Hardiman I concept. Like the arm system, it too is adaptable to other applications.

It should be noted that while the Hardiman servo systems were developed for a very high performance application, they can be adapted to applications with less severe performance requirements.

A further achievement in the field of servo analysis was the study of interactions between multiple servo controlled joints operated in series or cascade.

During the development of exoskeleton servos, it became apparent that the effect of interactions between servos in the series of joints in the arms or legs must be considered. These interactions have for a long time been a question in the design of manipulators. The past history has been to wonder about them, ignore them in design, and find no obvious ill effects in operation.

The Hardiman I presented a different situation than previously encountered. The needed servo performance was higher than ever before in manipulators; the force ratio (25:1) was high; the load (1500 lbs.) was much greater than previous experience. The instability resulting from the interaction between servos was a primary cause of the change from hydromechanical to electrohydraulic servos.

This study, covered by G.E. report S-68-1081 entitled "Special Technical Report on Joints in Series" dated 10 June 1969, established a method for stabilizing servo joints in series and can be used as a design guide for further development.

The mechanical design problem of packaging the 30 powered joints of the Hardiman into an assembly of reasonable size and matched to man's configuration has been one of major proportions.

Each of these joints has presented special problems in achieving the desired envelope while maintaining proper orientation between master and slave and the necessary control elements.

Design layouts illustrating the joint configurations are contained in Section 5. Many of these designs can be used as "building blocks" for synthesizing man-augmentation systems.

The development of the leg control system has been covered in previous technical reports (S-68-1060 "Special Interim Study" and S-68-1081 "Special Technical Report on Joints in Series"). The completion of the development and design of the more complex arm servo system is more recent and is covered in detail in Section 6.

SECTION 4

PLANNED PROGRAM COMPLETION

Present program plans are to complete checkout and demonstration of the first arm assembly; this is now in progress.

Additional program activities under present funding will include fabrication of one ankle inversion and foot rotate assembly to be added to the existing three joint leg assembly.

The next major step will be a fabrication program to produce the necessary parts to complete the leg and girdle assembly. A parallel effort is planned to produce parts for the second arm.

Assembly of the entire leg and girdle system will follow the fabrication effort. Operation and demonstration of the leg and girdle system will be the next milestone.

Final program activities will include assembly of the second arm, assembly of both arms to the leg and girdle system, and demonstration of the complete Hardiman prototype.

PART II

SECTION 5

MECHANICAL DESIGN

1. BACKGROUND

The mechanical design of the exoskeleton prototype, suitable for implementation of the "Machine Augmentation of Human Strength and Endurance" concept has been completed. Detail drawings of all required parts are ready for fabrication. As drawings are released for fabrication, changes will be made as necessary to reflect improvements revealed during manufacture or assembly.

2. MATERIALS

The major structural material for the exoskeleton is 6061 aluminum. This light material is available in a variety of shapes; it is readily welded and brazed, and can be heat treated to desired properties, either before or after fabrication.

Minor amounts of steel for pins and shafts, hardware, and actual cylinder walls have been used.

3. BEARINGS

Antifriction bearings are used at most rotating joints. Wherever possible, these are airframe bearings. These bearings are designed particularly for heavy loads with random, rather than continuous motion. The design load for these bearings is taken as 66 percent of the aircraft limit load as defined in MIL-B-7949A.

In some cases, bearings larger than the standard airframe bearings are needed. For this, special slim design ball bearings are used. No aircraft limit load is issued for these bearings. Each application was referred to the manufacturer for design guidance, since published load ratings are too conservative for the exoskeleton application. Linear actuator bearings are "Dyflon" lined monoball bearings.

4. BASIC SHAPE

Figure 1 shows the final conceptual design of the exoskeleton. Certain components, such as hydraulic hoses and tickler mechanisms, are omitted for clarity.

The slave hand form approximates that of a human hand. The lifting portion of the hand might be visualized as similar to a palm with fingers bent at the knuckles into a fixed, shallow vee-shape. An opposed thumb is provided, which can clamp various shapes into the vee. An articulated thumb tip allows curling of the thumb for greater shape adaptability. The thumb and thumb tip are not servo-controlled but have velocity control with force feedback to the operator.

The slave foot is 20 inches long by 8 inches wide. Arrangement can be made to clip on "snowshoe" extensions for better ground flotation on soft soil.

The load carrying members are box beams wherever this shape can be used. This construction is chosen for strength, lightness, and to contain and package the control and servo devices. Because of the space occupied by these parts, the shape of the box beams is necessarily somewhat complicated. These members are designed for fabrication by welding and/or brazing.

5. JOINT PARAMETERS

There are 30 joints (single degree of freedom axes) in the Exoskeleton, 15 in each leg-arm system; all are powered by linear hydraulic actuators except for the upper arm rotate and forearm rotate. These are not adaptable to linear actuators or require larger degrees of rotation, and are powered by single-vane hydraulic rotary actuators.

Listed below are the 15 joints. The following information is provided for each:

1. JOINT NUMBER - Axes number used in previous reports
2. RANGE - Total angular excursion (degrees)
3. FFB - Provision for force feedback in master
4. MAX. FORCE - Maximum force exerted by actuator (linear only) (lbs.)
5. MAX. TORQUE - Maximum torque exerted about each joint (in-lbs)

<u>JOINT MOTION</u>	<u>JOINT NUMBER</u>	<u>RANGE DEGREES</u>	<u>FFB</u>	<u>MAX. FORCE (lbs.)</u>	<u>MAX. TORQUE (lb-in)</u>
<u>Foot Assembly</u>					
Ankle Rotate	1	70	Indirect	5,238	14,792
Ankle Inversion	2	48	Indirect	3,628	14,512
Ankle Flex	3	80	Indirect	14,667	41,038
<u>Leg Assembly</u>					
Knee Flex	4	90	Indirect	9,378	29,830
Hip Flex	5	80	Indirect	11,853	50,553
Leg Abduction	6	41	Indirect	9,424	31,200
<u>Torso & Arm Assembly</u>					
Arm Abduction	7	65	Bilateral	4,790	14,970
Back Flex	8	90	Bilateral	14,676	67,070
Shoulder Flex	9	90	Bilateral	11,928	48,547
Upper Arm Rotate	10	55	Bilateral	--	12,000 (min.)
Elbow Flex	11	80	Bilateral	7,142	32,138
Forearm Rotate	12	160	Bilateral	--	4,000 (min.)
Wrist Flex	13	70	Bilateral	3,285	14,165
<u>Hand Assembly</u>					
Thumb Flex	14	80	Bilateral	2,945	4,049
Thumb Tip Flex	15	80	Bilateral	1,283	1,283

Figure 18 shows pictorially the excursions of the exoskeleton joints. It also includes a table listing the lengths of the 8 structural links from the ground to the load.

6. DESIGN LAYOUT DESCRIPTION

Foot Figure 19 Drawing #587E668

This drawing shows the slave and master foot. With Figure 21 it is the complete master/slave foot to the ankle flex joint. The common intersection of the ankle flex, ankle inversion, and foot rotate axes appears on the top view in the area I-9 and appears on the side view within the superimposed outline of the operator's foot (D-9). The three-degree-of-freedom foot of the exoskeleton simulates and is concentric with the natural ankle joint of the operator. Part 8 (F-11) is the yoke which connects the master foot, Part 1 (D-10), to the master leg at the ankle flex pivot. It is also shown in a rear view in the area D-3. The master leg system is constrained to the slave only in the foot rotate joint. This is a sliding joint allowing the operator to raise the master foot which generates an error signal in the tickler causing the slave foot to be raised. The slave portion of the foot is shown complete to the ankle inversion joint located behind the operator's foot. A partial rear view of the slave is shown in area I-3.

Foot (Tickler System) Figure 20 Drawing #587E668

This drawing shows the tickler input mechanisms which are located in the foot. These measure the displacement of the master from the slave and generate signals to reduce this displacement.

Leg (Ankle Inversion Housing) Figure 21 Drawing #587E590

This drawing shows the structural connection between the slave ankle inversion joint and the ankle flex joint. The ankle flex pivot is shown in end view in area B-12. The clevis pin for the ankle flex power actuator (not shown) is at C-11.

Slave Leg Figure 22 Drawing #587E590

Shown on this drawing are the slave shank and thigh which connect the ankle flex joint to the hip flex joint. Shown in outline is the side view of the ankle inversion housing described in Figure 21. Auxiliary views show the ankle flex shaft and the end view of the thigh. The knee is flexed to its minimum included angle to facilitate orientation on the paper. The servo valves, part number 105, and the stop valves, part number 15, for each of the three actuators are shown.

Slave Leg Sections Figure 23 Drawing #587E590

This drawing shows sections through the thigh and shank and refers to Figure 22. These illustrate the method of mounting the servo valves and stop valves for the three power actuators included in the leg. This is done utilizing manifolds shown as part nos. 101 and 102. Auxiliary sections further show the mounting arrangements in end view.

Leg (Master Leg and Tickler Control) Figure 24 Drawing #587E590

This drawing shows the shank and thigh (left leg) viewed from the operator's side. The master is seen as a rectangular tube with the ankle, knee, and hip flex joints coinciding with those of the slave leg. Auxiliary views show the one inch clearance between the slave and master. The broken rectangular outline shown about the ankle joint is the master yoke described in Figure 19. The tickler bodies are mounted on the slave and are connected to the master by means of sliding sleeve linkages. This results in measurement of displacement about one axis only.

Girdle Figure 25 Drawing #587E627

The girdle is the structural link between the two leg and arm systems and provides arm and leg abduction motions. This drawing shows the basic shape of the girdle as viewed from the side. The hip flex joint is shown at E-6 and the back flex joint at H-3. The leg and arm abduction axes intersect with a fixed included angle of 60 degrees. They intersect the hip and back flex joint axes at the centers of the pivot shafts. The master leg system and master arm system are not connected. The hip abduction power actuator is shown at the upper left. The servo and stop valve to control it are mounted directly on it by means of a manifold.

This drawing also shows the slave and master arm ab/ad joints which are mounted together but free to rotate independently. This forms the beginning of the master arm system and is the only place where the master is connected to the slave (except by tickler linkages).

The slave arm ab/ad shaft rotates on bearings mounted in the slave girdle. The master is mounted by bearings on the slave shaft as shown in area G-3. The upper section of the slave shaft is machined to form the back flex joint and back flex power actuator clevis connection.

Master Girdle and Hip Flex Tickler Figure 26 Drawing #587E627

This drawing shows the connecting link between the master hip joint and the master "leg ab/ad" noted on the previous drawing, Figure 25 (E-5). This link is best shown on the top view where it lays parallel to the slave ab/ad shaft, then bends 90° and forms a cylinder around this shaft. It is shown in dotted outline in the side view (lower left). Here it is mated with the cross-over link which connects the two master leg systems. Only one half of this cross-over link appears in the top view. It is comprised of a rectangular tube with cylindrical bearing surfaces on each end.

Master Girdle and Hip AB/AD Tickler Figure 27 Drawing #587E627

This drawing shows the master girdle connecting link from the front along with the hip ab/ad tickler which is connected to it. Also shown in the side view is a vertical member which is part of the harness apparatus that will be used to fasten the operator to this link. This member is bolted to the girdle connecting link. The operator is shown as a dotted line. Part of the waist strap is shown just forward of the vertical member.

Girdle (Slave) Figure 28 Drawing #587E627

This drawing is a top view of the girdle showing the slave arm ab/ad components. These components are located within the girdle as shown in previous drawings. Also shown are the servo valves controlling the power actuators. The tickler body for measuring the master/slave ab/ad displacement is shown mounted on the slave ab/ad shaft H-5 and H-11.

Girdle (Slave and Partial Master) Figure 29 Drawing #587E627

This drawing shows the force feedback actuator for arm ab/ad. The head end is mounted on the girdle and the rod clevis is connected to the master arm ab/ad member. Mounted on the actuator is a velocity transducer which is part of the control system. Shown in the lower left is the master arm ab/ad member including the back flex joint and actuator connection point.

Back Link Slave Figure 30 Drawing #587E636

This drawing shows the slave back link. On the left is the side view in section showing the back flex joint at C-11 and the shoulder flex joint at H-13. The shoulder flex and back flex power actuators are shown including the method of connecting the hydraulic hoses. Mounted on the outboard side is the stop valve manifold assembly described later in Figure 31. The back flex tickler body is mounted on the operator's side and is connected to the master back link (not shown).

Stop Valve Manifold Assembly (Back J) Figure 31 Dwg. #422D703

This drawing shows the mounting manifold for the servo and stop valves used to control the back flex, shoulder flex and upper arm rotate actuators. This is mounted on the outboard side of the slave back link as shown in Figure 30. The shoulder pivot is noted at E-8. The manifold serves as a common supply and return for the three servo systems mentioned plus has provision for supply and return for the remaining arm joints. Each servo/stop valve system has two output pairs. One pair controls the power actuators located in the slave, and the other controls the force feedback actuators located in the master.

Assembly - Backlink - Master Figure 32 Drawing #587E637

The master back link is connected to the master arm ab/ad member described in Figure 29 to form the back flex joint. It is connected to the master "shoulder", part number 3 (E-3), to form the shoulder flex joint. Force feedback at each joint is provided by the small actuators shown. Each joint also has a linear velocity transducer to provide inputs to the control system. These are mounted inside the rectangular tube and are shown by dotted lines at C-11 and C-8. Section line C-C shows the transducers at the lower right.

Upper Arm Assembly

Figure 33

Drawing #587E635

This drawing shows the slave and master upper arm. The shoulder flex and elbow flex joints are noted at C-8 and E-12 respectively in the side view (lower left). The upper arm is controlled by the shoulder flex actuator mounted in the back link and connected to the pin shown at B-7. Mounted on top of the slave upper arm is the elbow flex power actuator which controls the slave forearm. This actuator and its servo/stop valve are shown at F-10 in the side view. The upper arm rotate axis is noted at D-11. The upper arm rotate power actuator (located at D-10) is bolted to the shoulder flex pivot block and connected to the outer housing of the upper arm by the splined shaft D-11. The outer housing rotates about the bearings, parts numbered 45 and 46, noted at A-11 and A-9.

The master upper arm is shown best in the end view and top view. The upper arm rotate force feedback actuator is shown at D-7, D-4, and H-7. The only connections to the slave are from the back flex and upper arm rotate ticklers mounted on the slave.

Upper Arm Master

Figure 34

Drawing #587E780

This drawing shows the shape of the master upper arm which appears in Figure 33. The elbow flex force feedback actuator (not shown) is mounted inside the rectangular tube at I-12.

Forearm and Hand (Top View)

Figure 35

Drawing #587E634

This drawing shows the slave and master from the elbow flex joint to the hand. The elbow flex axis is identified by section line E-E. The wrist flex joint is shown in end view at G-8. The forearm rotate actuator noted at E-5 drives the inner slave housing on two bearings, part 92. The small rotary actuator mounted on the master at H-5 provides force feedback. In the slave hand are contained the wrist flex, thumb flex, and thumb tip power actuators. The thumb and thumb tip are controlled by valves in the master hand. Force feedback is achieved by internal porting of the hydraulic pressure which opposes the operator's input. The wrist flex force feedback actuators are noted at H-8. Also seen in this drawing are the ticklers for elbow flex (F-6), forearm rotate (H-7), and wrist flex (F-9).

Forearm and Hand Side View

Figure 36

Drawing #587E634

This drawing shows the slave forearm and hand in side view. The forearm rotate actuator is located inside the housing at C-5. The wrist flex tickler is located at E-9. Shown mounted below the wrist flex actuator is the servo and stop valve which control it.

Assembly Forearm and Hand

Figure 37

Drawing #587E634

This drawing shows the master hand in side view. Portions of the slave shown are the forearm rotate housing which surrounds the master, and the end of the slave hand. The master elbow flex joint is at the extreme right (G-5). The shape of the hand grip can be seen as well as the levers controlling the thumb and thumb tip valves. The thumb is controlled by pushing the lever (which is pivoted at the lower left of the thumb flex valve) with the palm of the operator's hand. The thumb tip is controlled by depressing the spool shown at H-10 with the operator's thumb. This spool is pivoted at the upper right of the thumb tip valve.

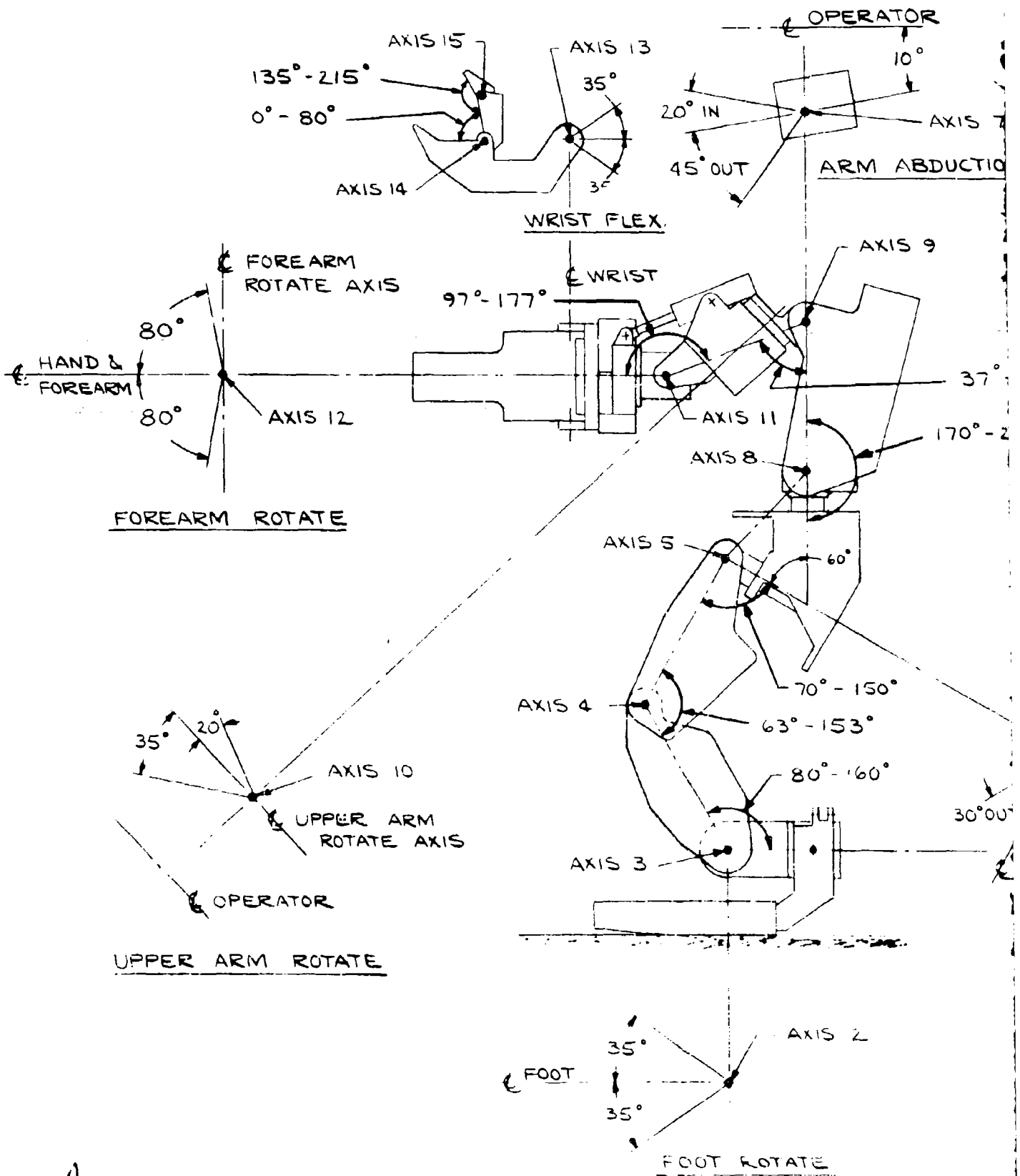

A.

OPERATOR

KINEMATIC LENGTHS

LINK	FROM AXIS	TO AXIS	LENGTH
FOOT	GROUND	3	9.25
SHANK	3	4	19.00
THIGH	4	5	19.00
GIRDLE	5	8	13.20
BACK	8	9	15.80
UPPER ARM	9	11	15.62
FOREARM	11	13	9.75
HAND	13	LOAD	13.00

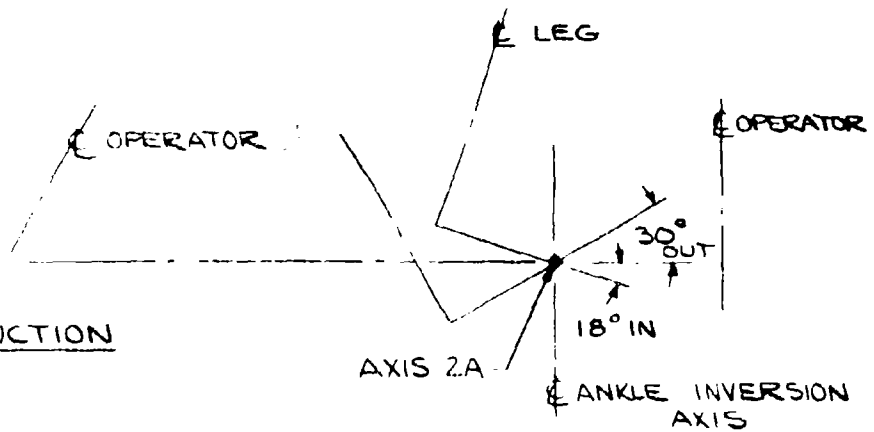
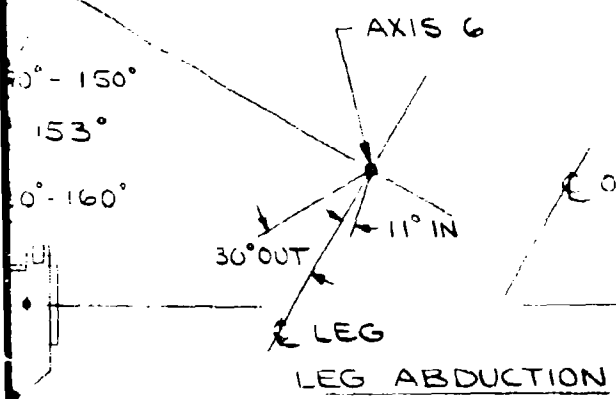
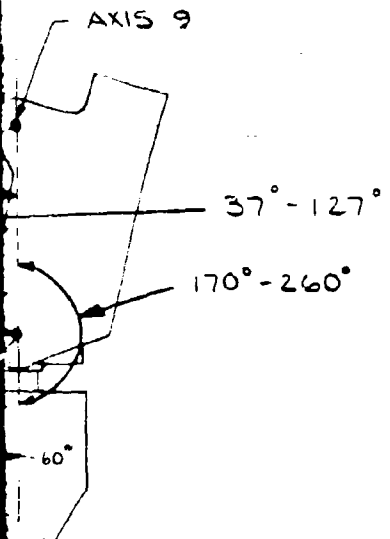
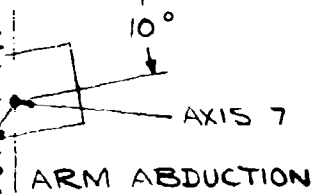

ANKLE INVERSION

Figure 18. Angular Excursions of Joints

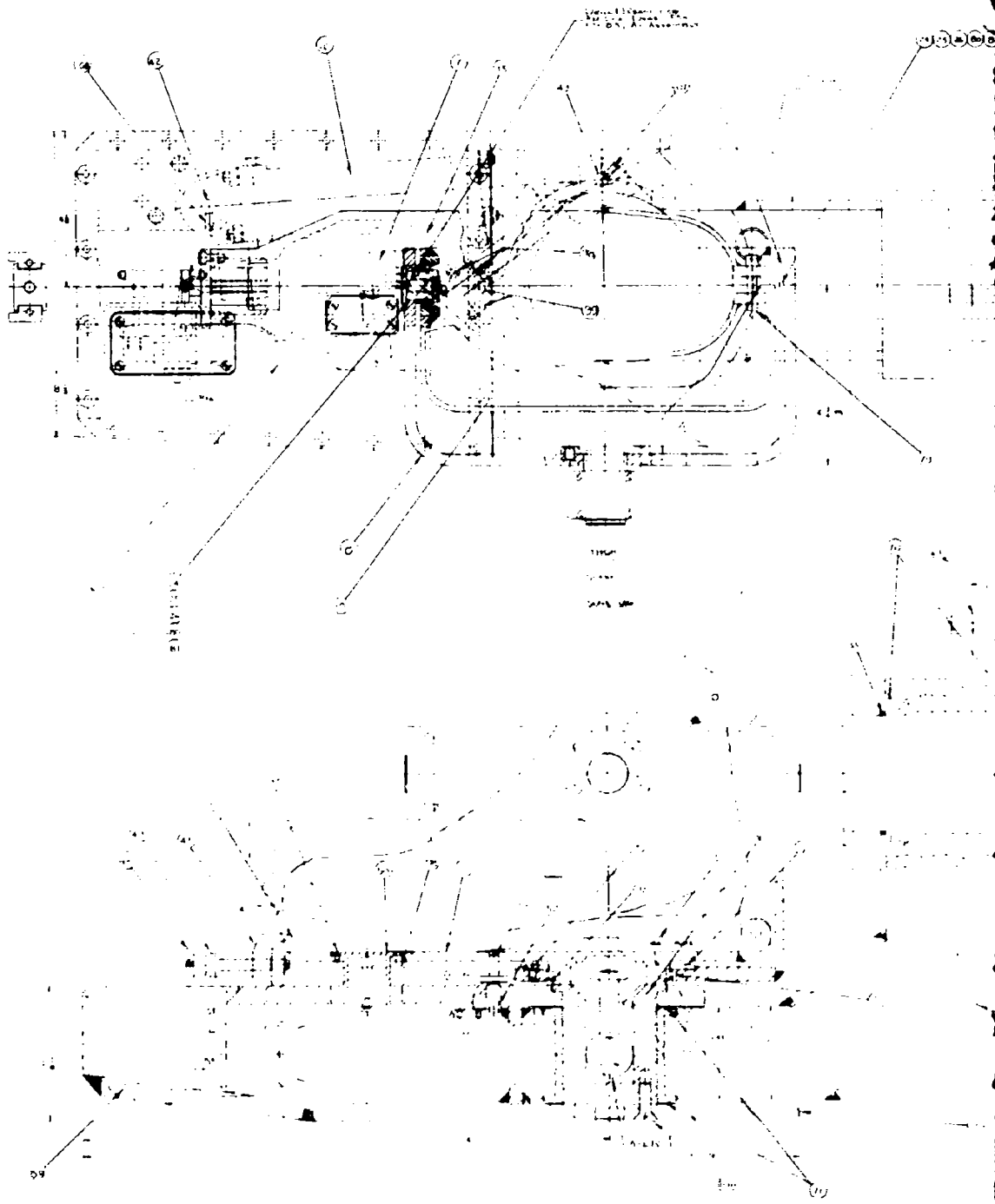
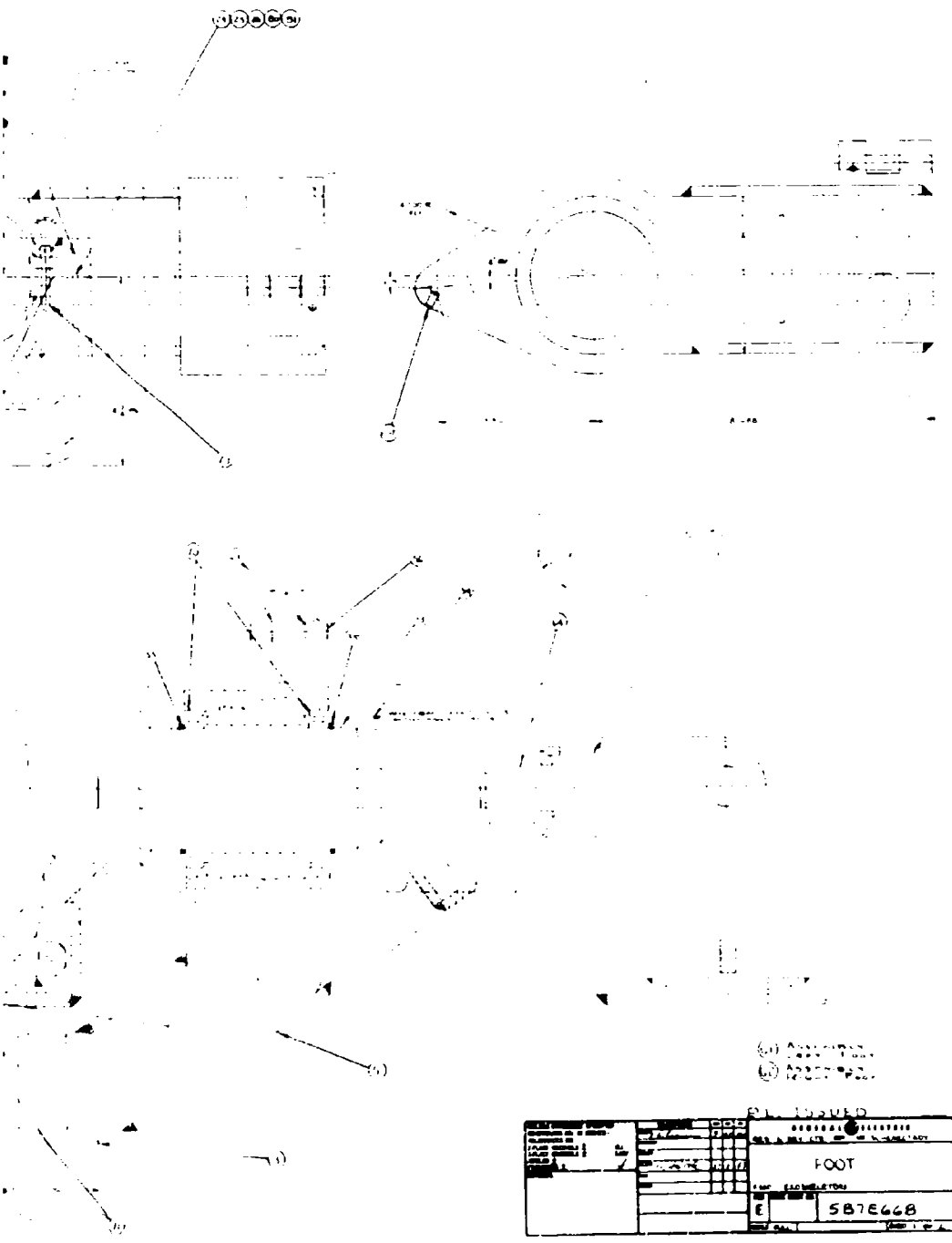

Figure 19. Foot

A.



- (k) Assembly
- (l) Assembly

PART DISCUSSION		PART NUMBER	
NAME	FOOT	QUANTITY	1
DATE	11/17/77	ISSUE	1
BY		APPROVED	
CHKD		DATE	
APP'D			
REV			
DESCRIPTION	E 587E668		

Figure 19. Foot

P



Figure 20. Foot Ticker System

A.

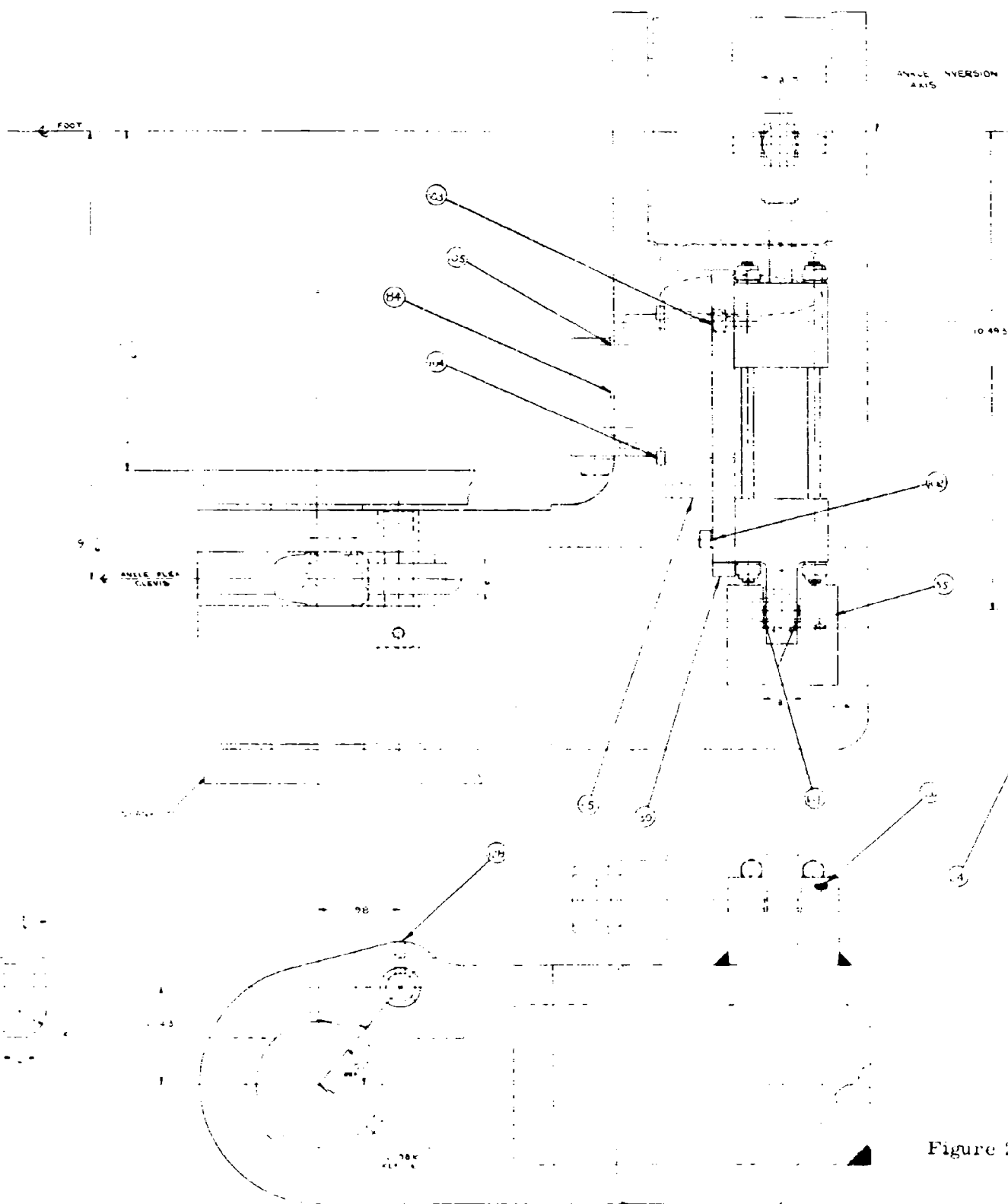
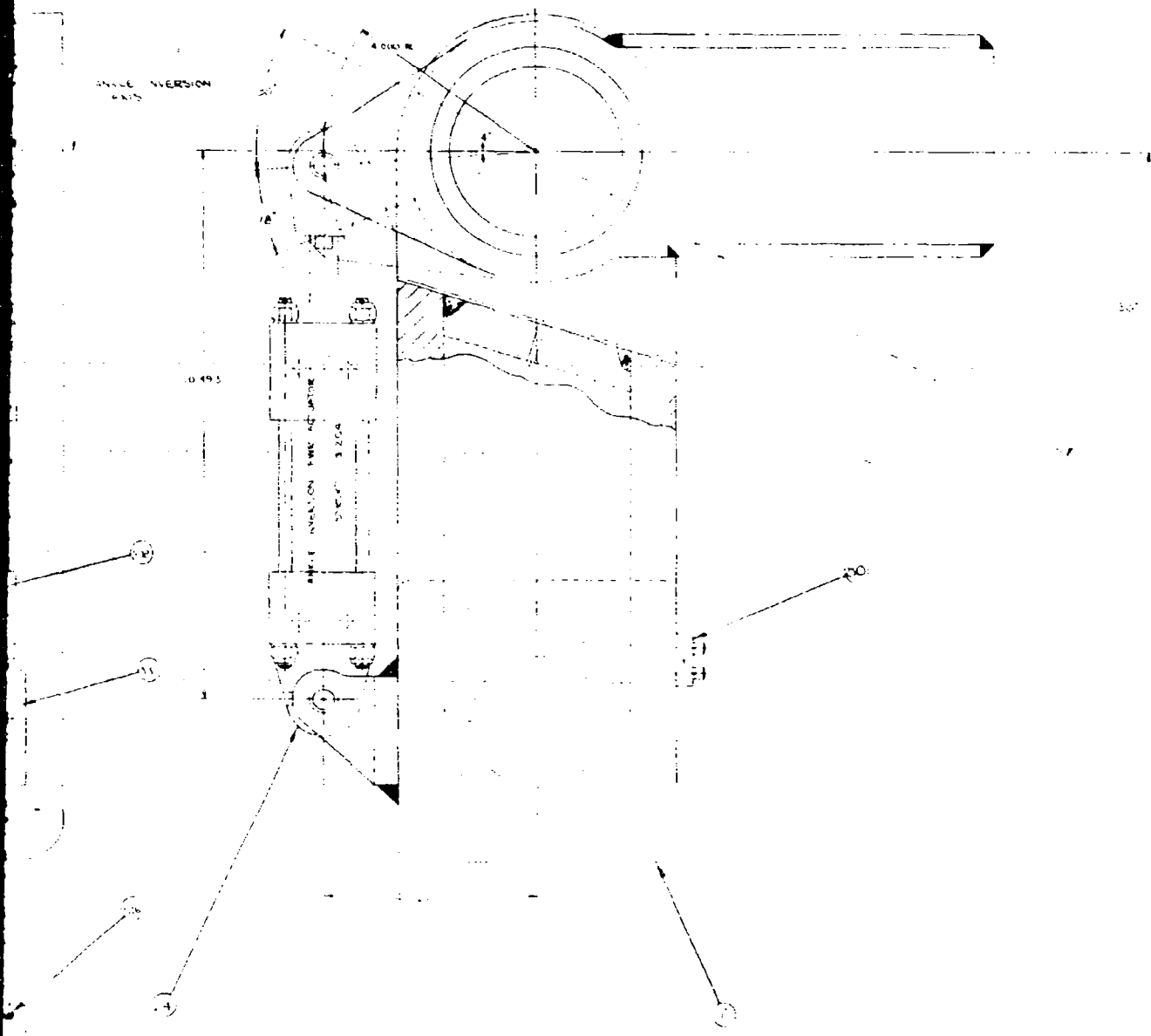

Figure 21.

A



PL ISSUED

UNLESS OTHERWISE SPECIFIED DIMENSIONS ARE IN INCHES - DECIMALS & FRACTIONS 2 PLACES IN CIRCLES & 3 PLACES IN CIRCLES & ANGLES & FRACTIONS & MATERIAL	QUANTITY 1	PART NO. 587E590	REV. & DATE 1	DESIGNED BY EROD/ALL/TEM
	DRAWN BY EROD/ALL/TEM	CHECKED BY EROD/ALL/TEM	APPROVED BY EROD/ALL/TEM	TITLE (ANKLE INVERSION HOUSING GLAVE) LEG
SIZE E	CODE EROD/ALL/TEM	IDENT NO. 587E590	SHEET 4 OF 4	

Figure 21. Ankle Inversion Housing

B.

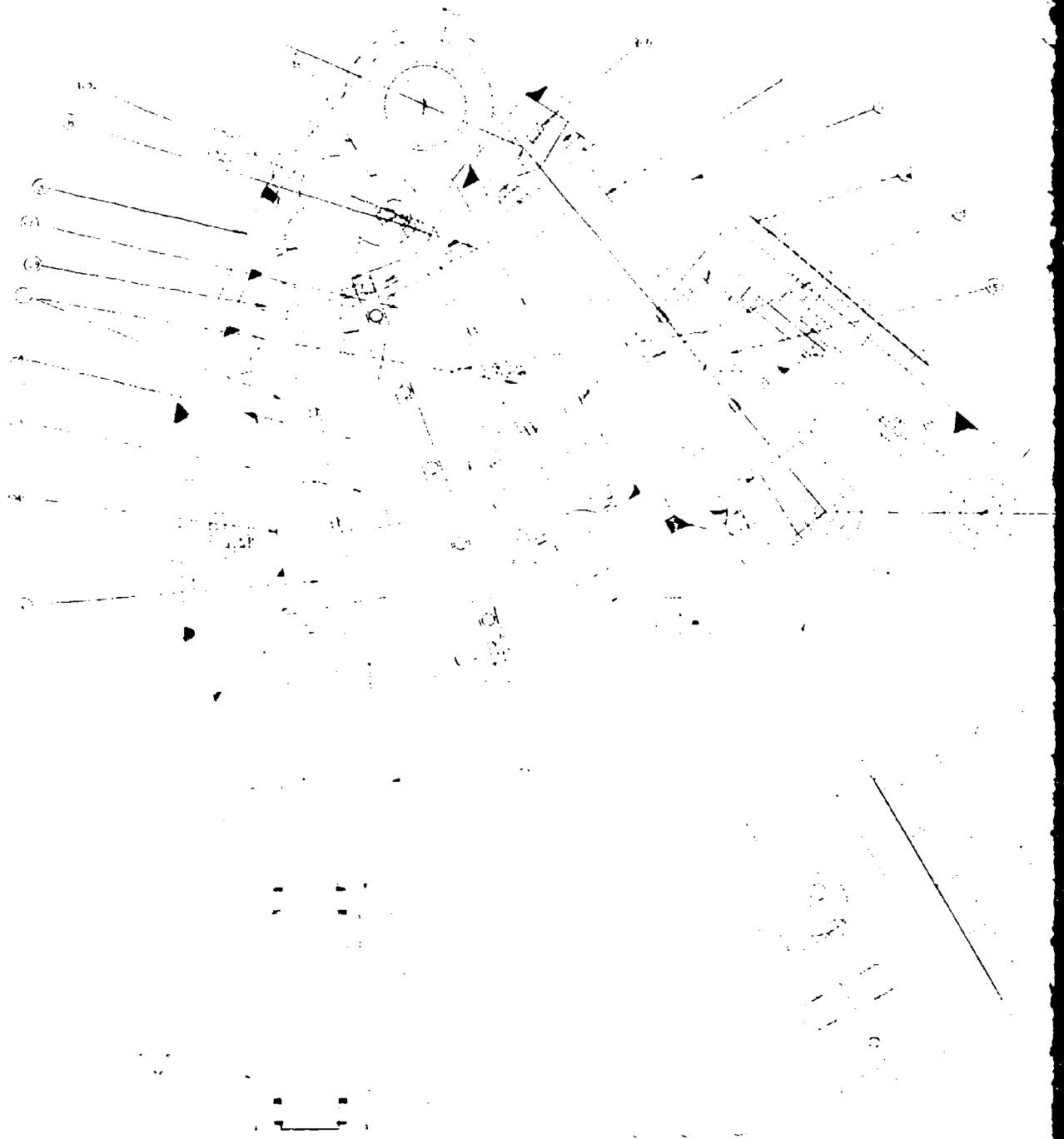

Figure 22. Slave Leg



Figure 22. Slave Leg

B.

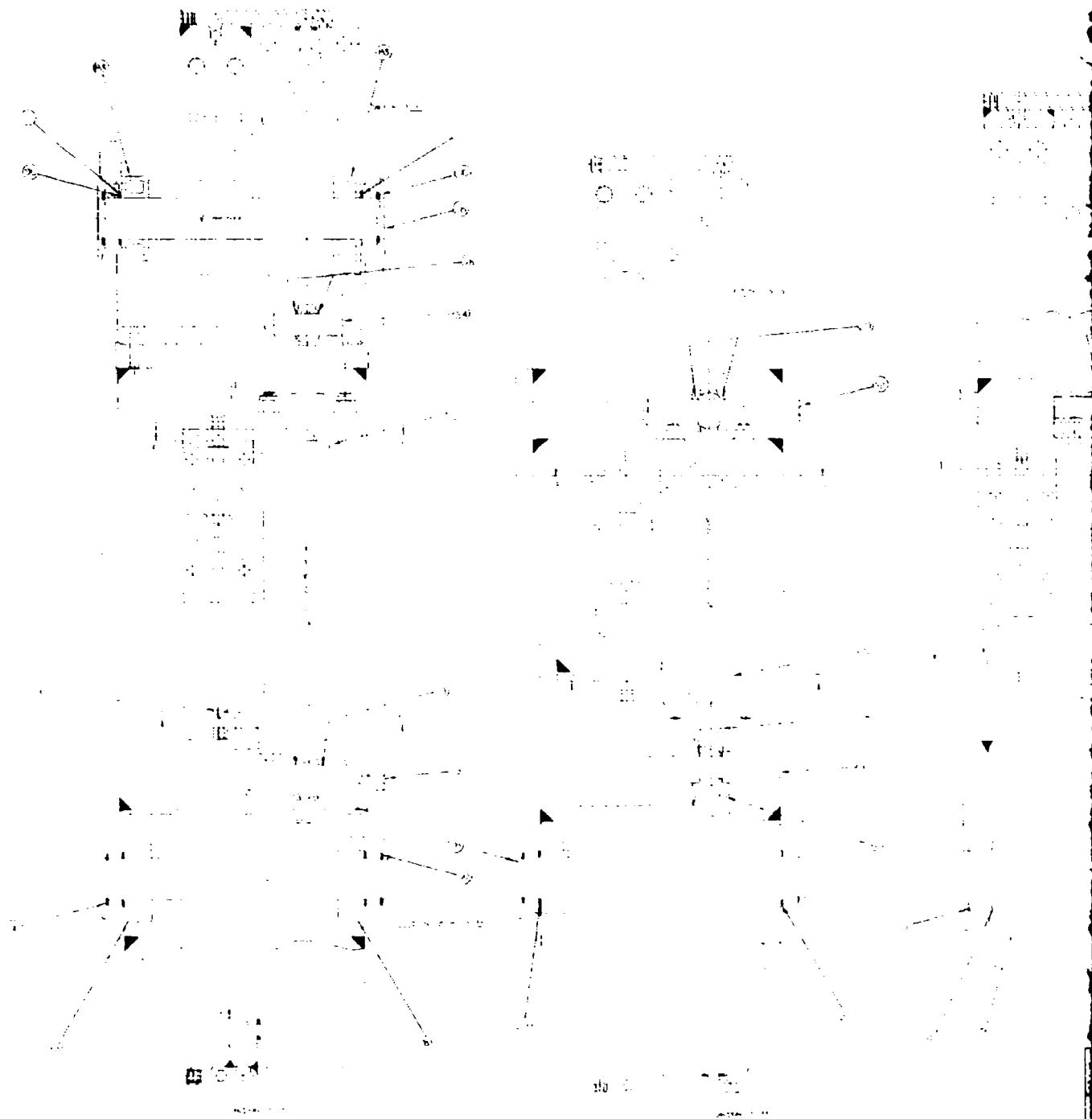
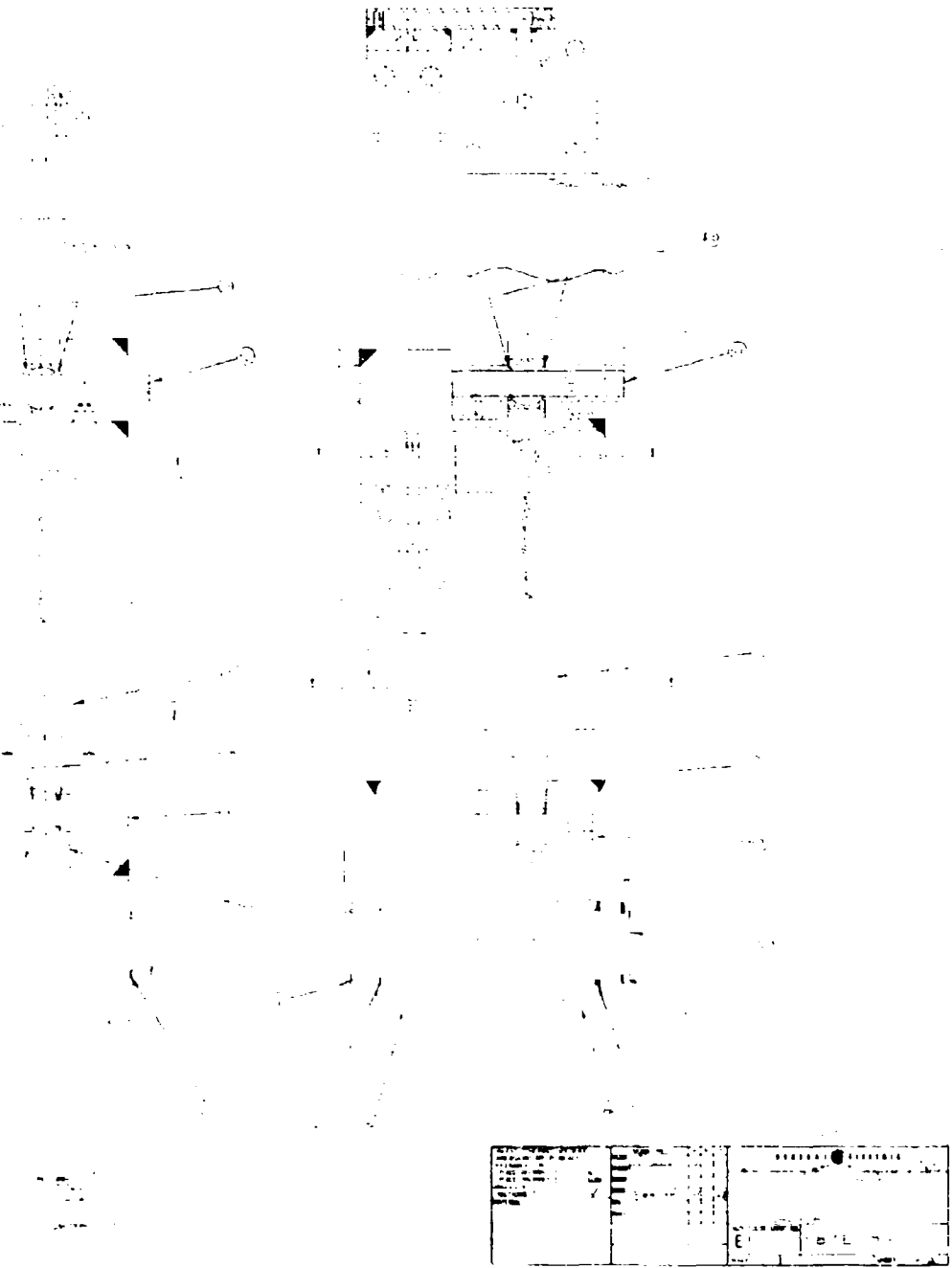

Figure 23. Slave Log Sections

A



23. Slave Log Sections

E

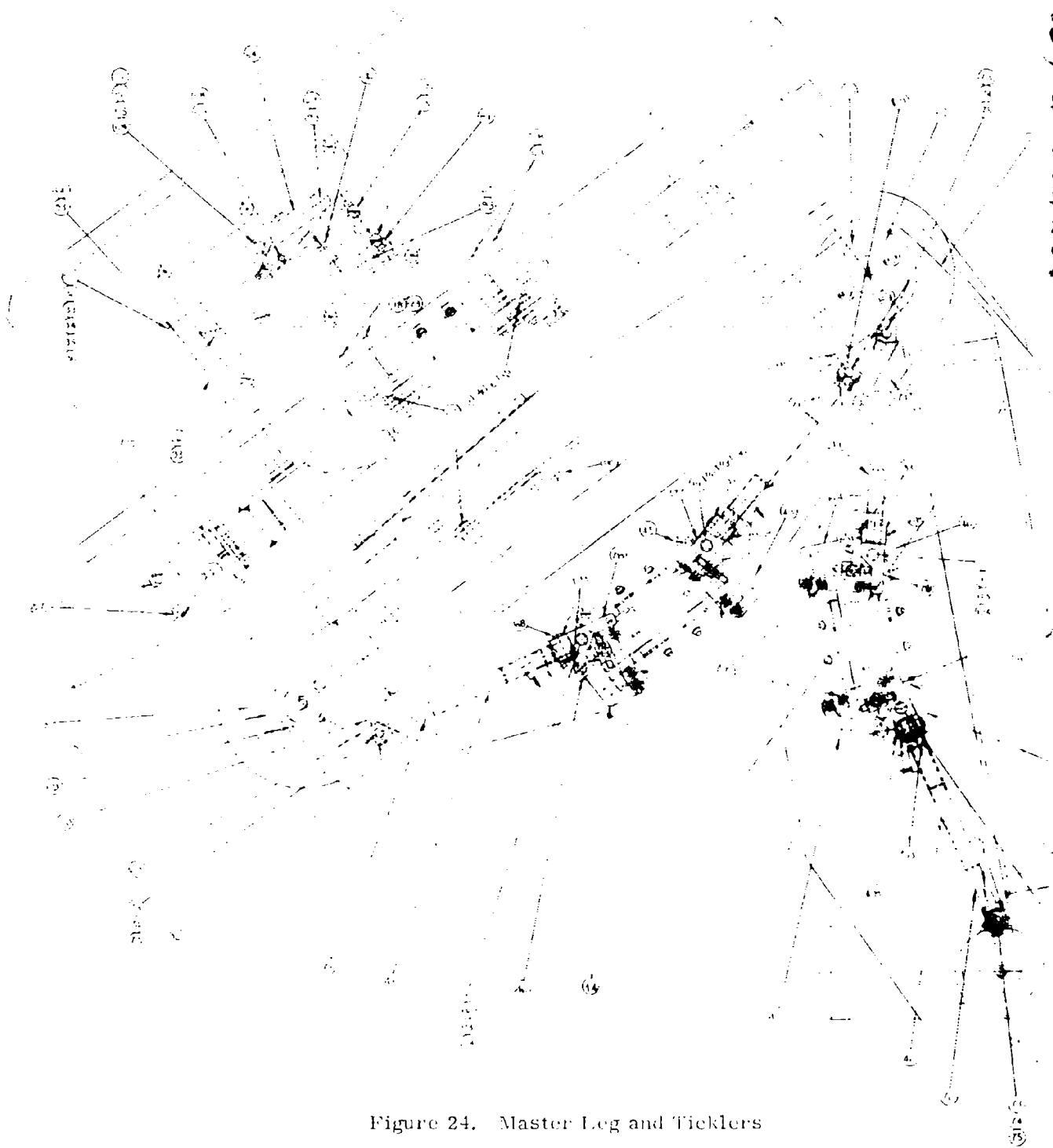
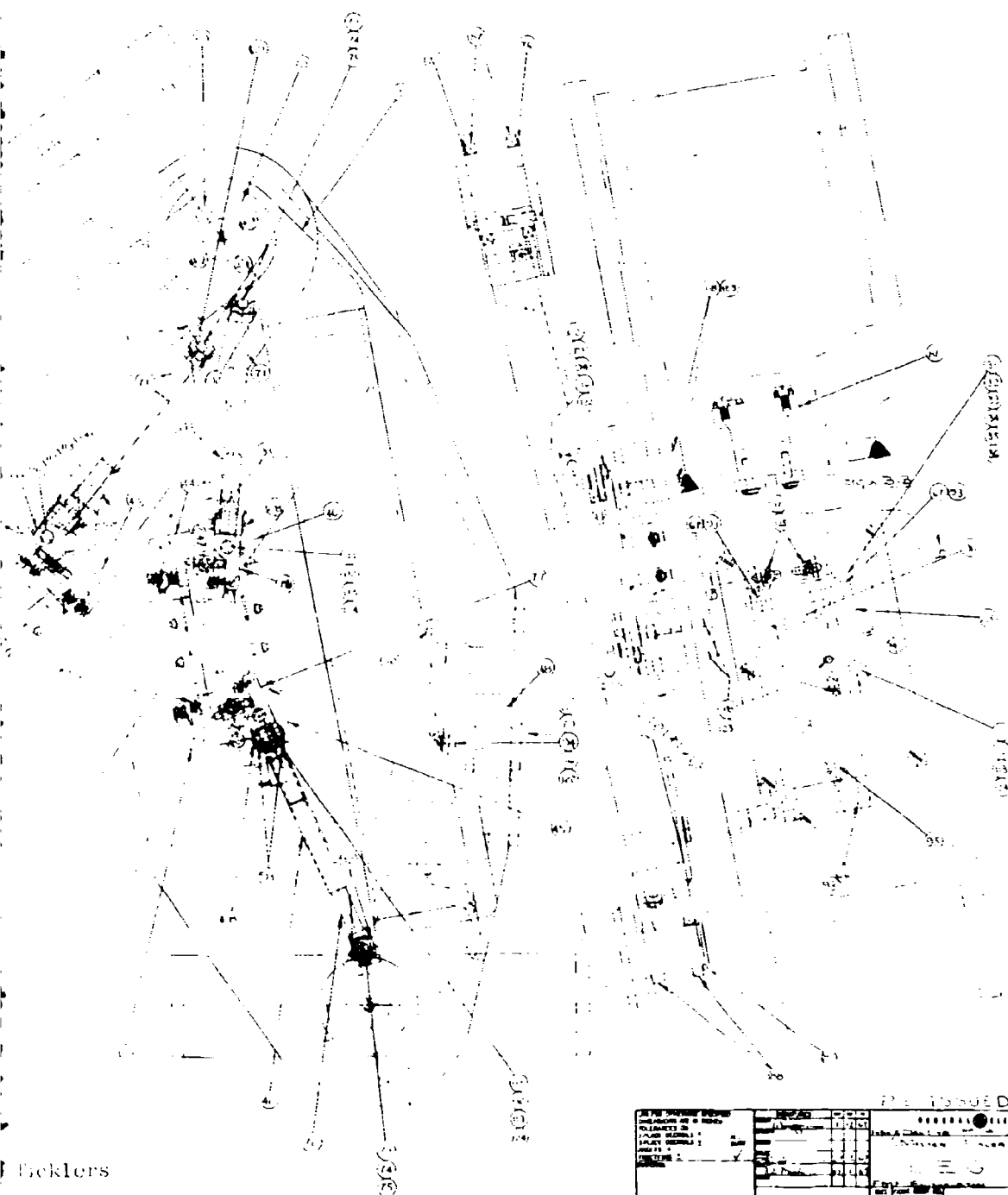

Figure 24. Master Leg and Ticklers

A.



Ecklers

P. 10410 D

DATE PREPARED: _____ DRAWN BY: _____ CHECKED BY: _____ SCALE: _____ SHEET NO.: _____ TOTAL SHEETS: _____	<table border="1"> <tr> <td>NO.</td> <td>REV.</td> <td>DATE</td> <td>BY</td> <td>DESCRIPTION</td> </tr> <tr> <td> </td> <td> </td> <td> </td> <td> </td> <td> </td> </tr> <tr> <td> </td> <td> </td> <td> </td> <td> </td> <td> </td> </tr> </table>	NO.	REV.	DATE	BY	DESCRIPTION											GENERAL ELECTRIC (Division of General Electric) NEW YORK, N. Y. 5705 590
NO.	REV.	DATE	BY	DESCRIPTION													

B.

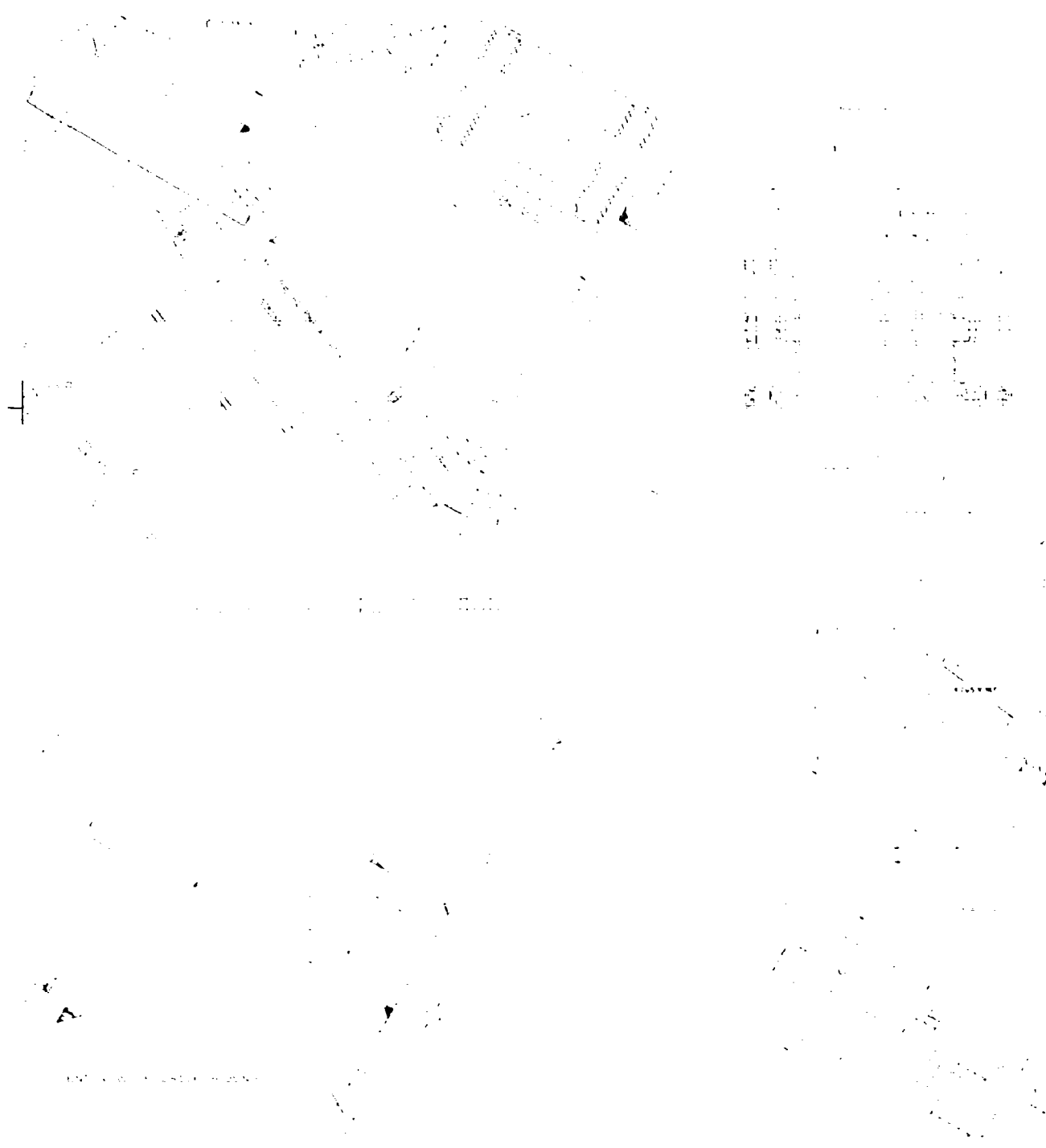

Figure 25. Girdle

A/



GENERAL INFORMATION PROJECT NO. 100-10000 DRAWING NO. 100-10000-100 SHEET NO. 100-10000-100-100		GENERAL PURPOSE 100-10000-100-100	
DATE 100-10000-100-100 BY 100-10000-100-100 CHECKED 100-10000-100-100 APPROVED 100-10000-100-100		100-10000-100-100 100-10000-100-100	

Figure 25. Circle



Figure 26. Master Girdle and Hip Flex Tickler

11

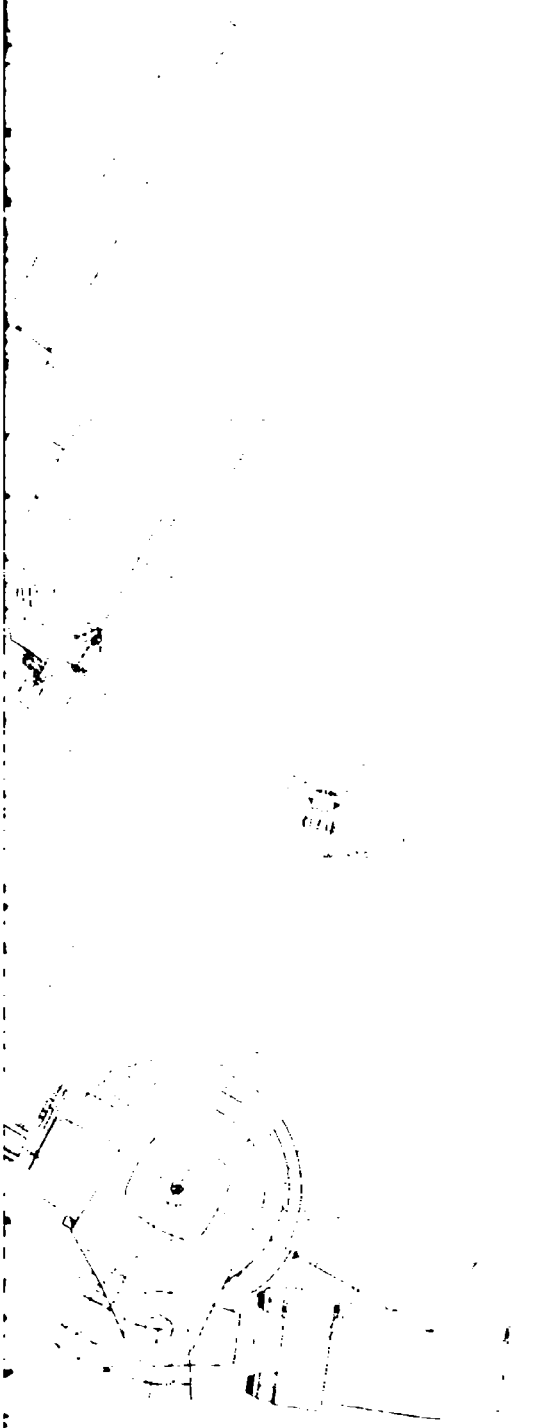

587E627

GENERAL INFORMATION	
DATE	12-2
TIME	
LOCATION	
OPERATOR	
REMARKS	
E	

Tiekler

Li

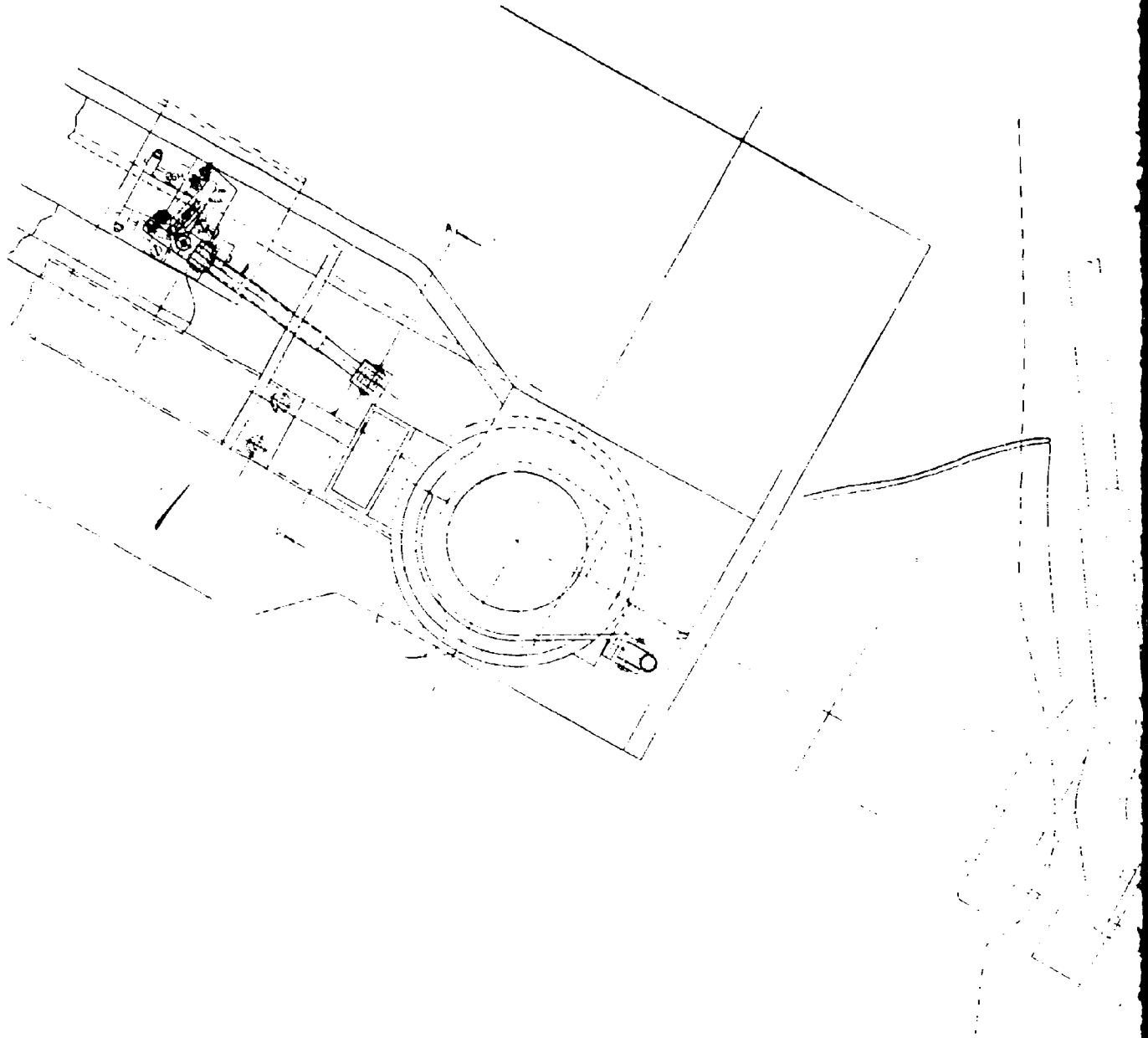
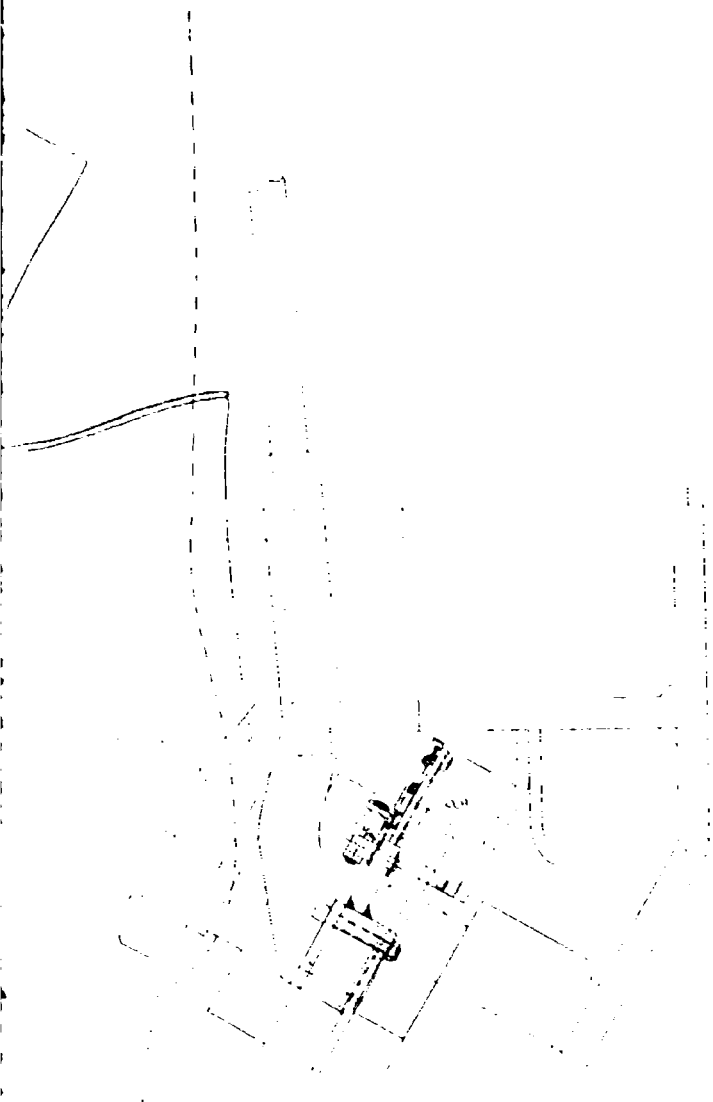

Figure 27. Master Girdle and Hip AB/AD Tackler

Sheet AA

A.



System A.A.

5871627

GENERAL INFORMATION		REVISED		DATE	
DESCRIPTION		1	1		
QUANTITY					
UNIT OF MEASURE					
PRICE					
DATE					
REVISIONS					
REVISION					
DATE					
BY					
CHECKED					
APPROVED					
DATE					

B.

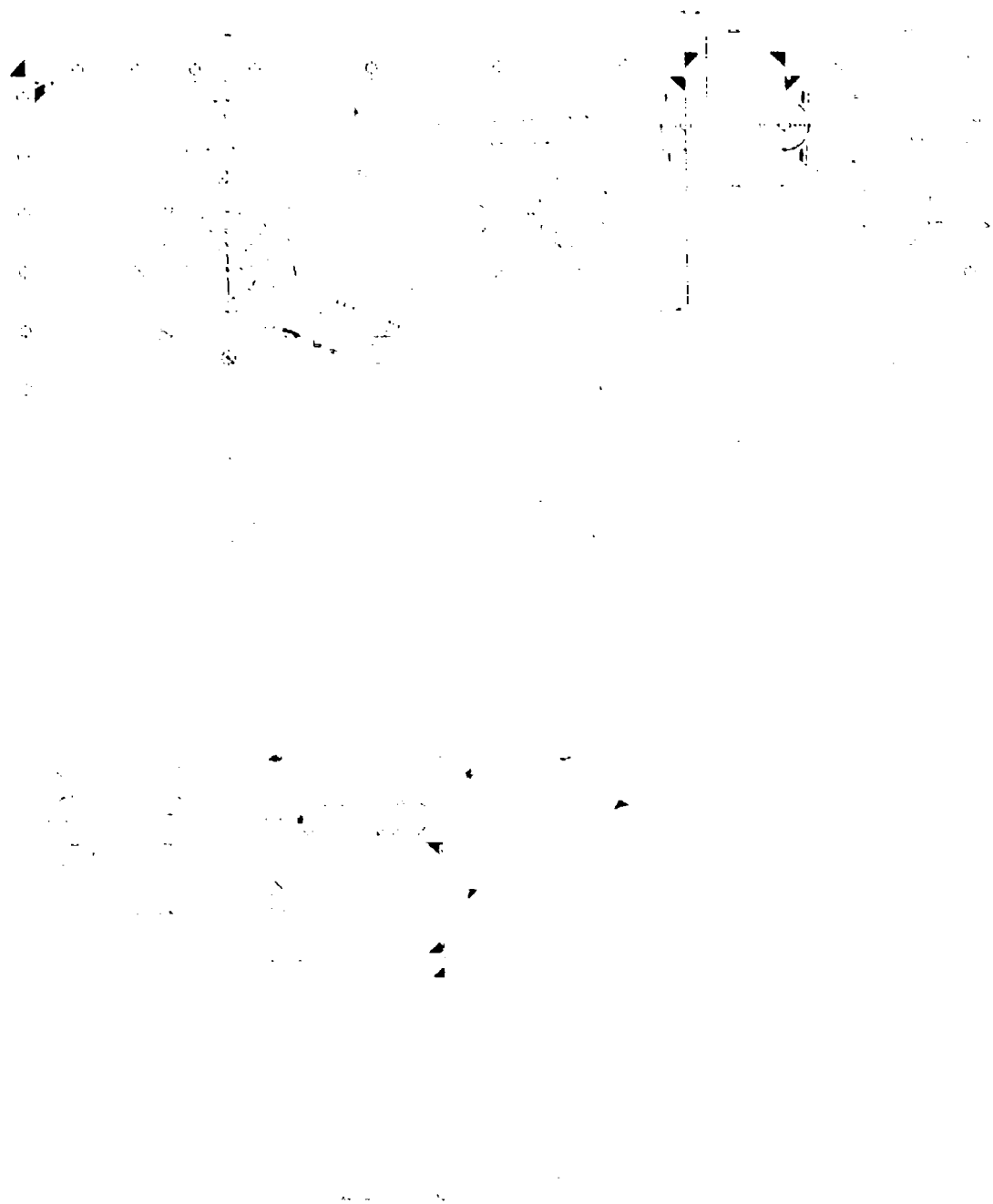

Figure 29. Slave Grille

A



GENERAL INFORMATION	
1. NAME	Slave Girdle
2. DRAWN BY	
3. CHECKED BY	
4. DATE	
5. SCALE	
6. MATERIAL	
7. FINISH	
8. WEIGHT	
9. COMMENTS	

Figure 26. Slave Girdle

R



Figure 29. Slave Girdle - Master AB/AD

A.

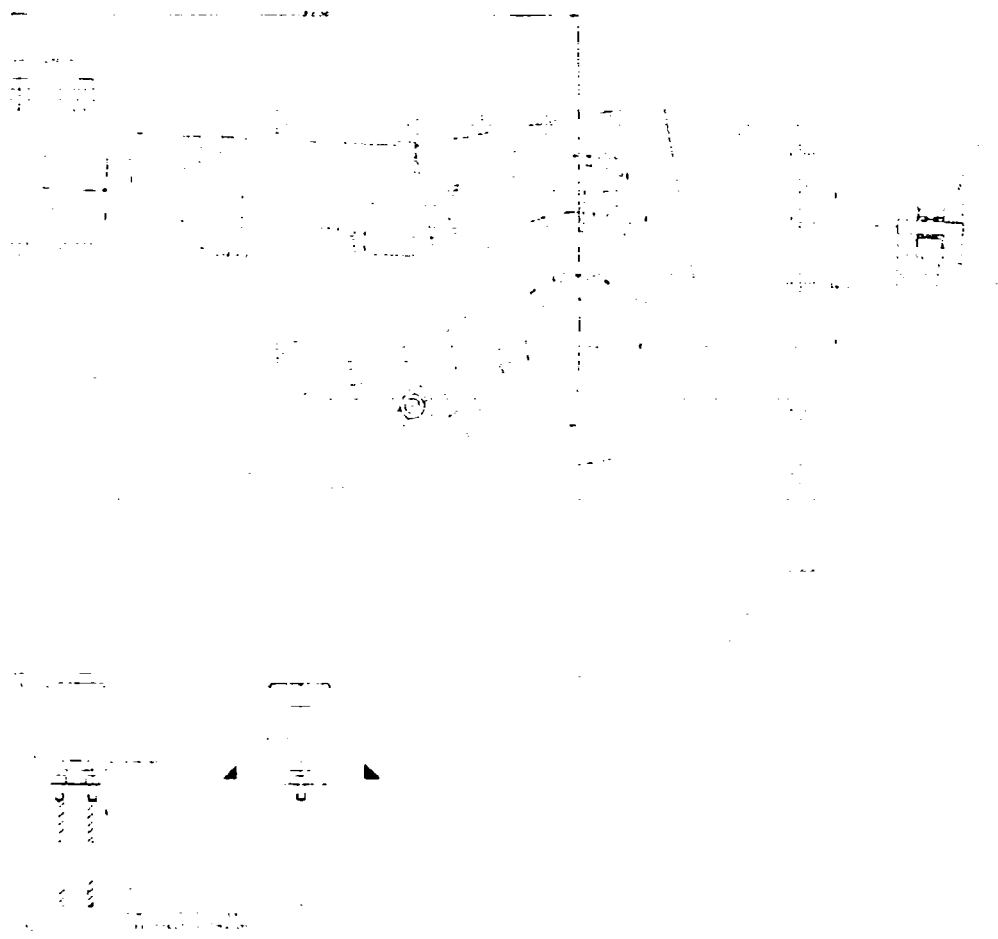

GENERAL ENVELOPE	
NO. 1	NO. 2
NO. 3	NO. 4
NO. 5	NO. 6
NO. 7	NO. 8
NO. 9	NO. 10
NO. 11	NO. 12
NO. 13	NO. 14
NO. 15	NO. 16
NO. 17	NO. 18
NO. 19	NO. 20
NO. 21	NO. 22
NO. 23	NO. 24
NO. 25	NO. 26
NO. 27	NO. 28
NO. 29	NO. 30
NO. 31	NO. 32
NO. 33	NO. 34
NO. 35	NO. 36
NO. 37	NO. 38
NO. 39	NO. 40
NO. 41	NO. 42
NO. 43	NO. 44
NO. 45	NO. 46
NO. 47	NO. 48
NO. 49	NO. 50
NO. 51	NO. 52
NO. 53	NO. 54
NO. 55	NO. 56
NO. 57	NO. 58
NO. 59	NO. 60
NO. 61	NO. 62
NO. 63	NO. 64
NO. 65	NO. 66
NO. 67	NO. 68
NO. 69	NO. 70
NO. 71	NO. 72
NO. 73	NO. 74
NO. 75	NO. 76
NO. 77	NO. 78
NO. 79	NO. 80
NO. 81	NO. 82
NO. 83	NO. 84
NO. 85	NO. 86
NO. 87	NO. 88
NO. 89	NO. 90
NO. 91	NO. 92
NO. 93	NO. 94
NO. 95	NO. 96
NO. 97	NO. 98
NO. 99	NO. 100

Girdle - Master AB/AD

R.

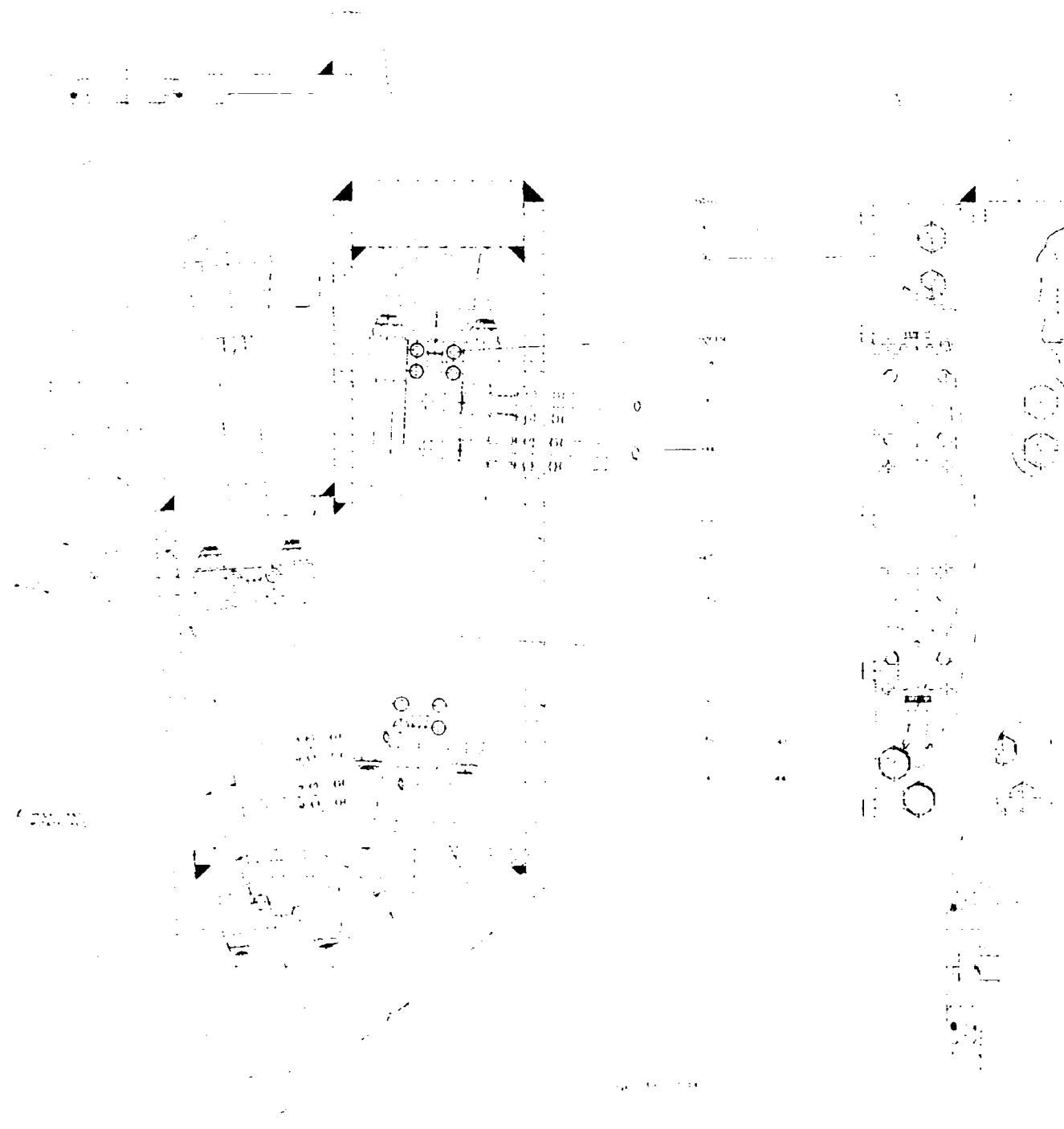
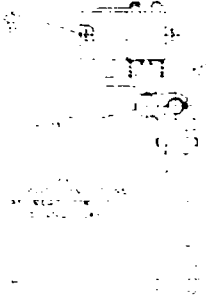
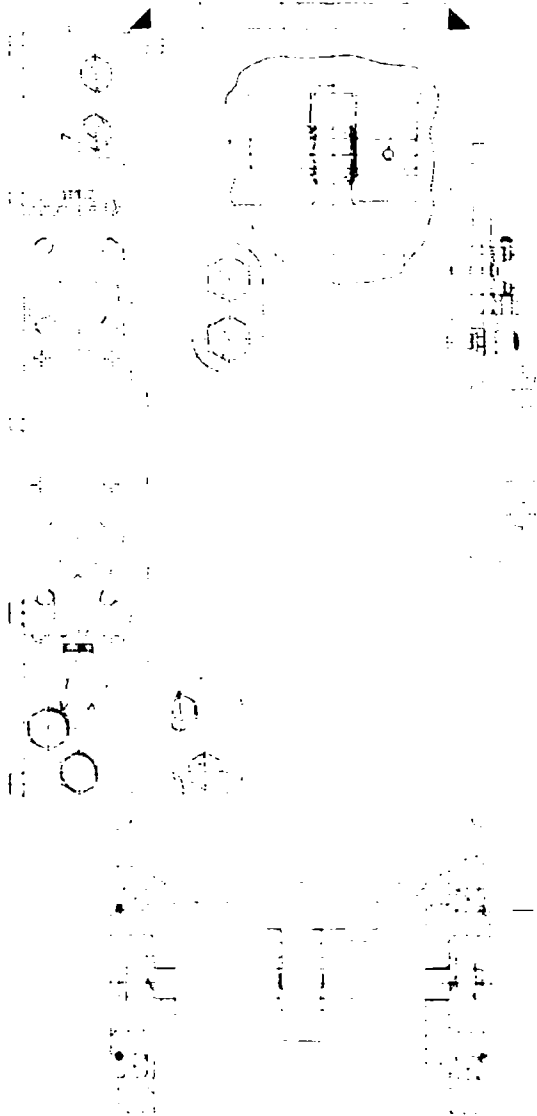

Figure 30. Backlink Slave

A.



ALPHA OVERVIEW SHEET		REVISED		GENERAL ELECTRIC	
DRAWING NO. 1000000000		DATE		REV. 1	
DRAWING TITLE		DATE		REV. 2	
DRAWING NO. 1000000000		DATE		REV. 3	
DRAWING TITLE		DATE		REV. 4	
DRAWING NO. 1000000000		DATE		REV. 5	
DRAWING TITLE		DATE		REV. 6	
DRAWING NO. 1000000000		DATE		REV. 7	
DRAWING TITLE		DATE		REV. 8	
DRAWING NO. 1000000000		DATE		REV. 9	
DRAWING TITLE		DATE		REV. 10	
DRAWING NO. 1000000000		DATE		REV. 11	
DRAWING TITLE		DATE		REV. 12	
DRAWING NO. 1000000000		DATE		REV. 13	
DRAWING TITLE		DATE		REV. 14	
DRAWING NO. 1000000000		DATE		REV. 15	
DRAWING TITLE		DATE		REV. 16	
DRAWING NO. 1000000000		DATE		REV. 17	
DRAWING TITLE		DATE		REV. 18	
DRAWING NO. 1000000000		DATE		REV. 19	
DRAWING TITLE		DATE		REV. 20	
DRAWING NO. 1000000000		DATE		REV. 21	
DRAWING TITLE		DATE		REV. 22	
DRAWING NO. 1000000000		DATE		REV. 23	
DRAWING TITLE		DATE		REV. 24	
DRAWING NO. 1000000000		DATE		REV. 25	
DRAWING TITLE		DATE		REV. 26	
DRAWING NO. 1000000000		DATE		REV. 27	
DRAWING TITLE		DATE		REV. 28	
DRAWING NO. 1000000000		DATE		REV. 29	
DRAWING TITLE		DATE		REV. 30	
DRAWING NO. 1000000000		DATE		REV. 31	
DRAWING TITLE		DATE		REV. 32	
DRAWING NO. 1000000000		DATE		REV. 33	
DRAWING TITLE		DATE		REV. 34	
DRAWING NO. 1000000000		DATE		REV. 35	
DRAWING TITLE		DATE		REV. 36	
DRAWING NO. 1000000000		DATE		REV. 37	
DRAWING TITLE		DATE		REV. 38	
DRAWING NO. 1000000000		DATE		REV. 39	
DRAWING TITLE		DATE		REV. 40	
DRAWING NO. 1000000000		DATE		REV. 41	
DRAWING TITLE		DATE		REV. 42	
DRAWING NO. 1000000000		DATE		REV. 43	
DRAWING TITLE		DATE		REV. 44	
DRAWING NO. 1000000000		DATE		REV. 45	
DRAWING TITLE		DATE		REV. 46	
DRAWING NO. 1000000000		DATE		REV. 47	
DRAWING TITLE		DATE		REV. 48	
DRAWING NO. 1000000000		DATE		REV. 49	
DRAWING TITLE		DATE		REV. 50	

Figure 30. Back Link Slave

B.

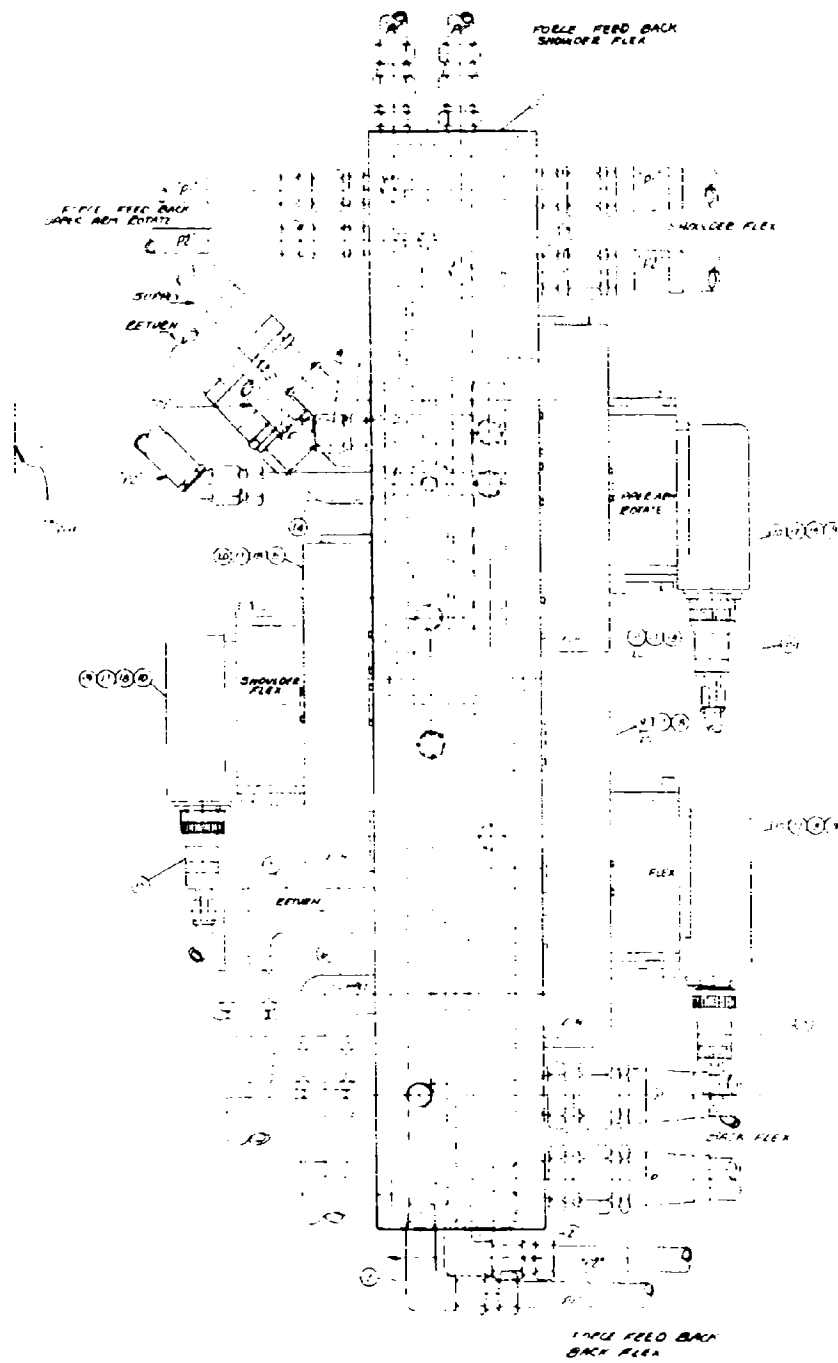

UNLESS OTHERWISE SPECIFIED	SIGNATURE
DIMENSIONS ARE IN INCHES	<i>[Signature]</i>
TOLERANCES UNLESS OTHERWISE SPECIFIED	DATE
1/16" DECIMALS	11/11/50
1/32" DECIMALS	BY
ANGLES	<i>[Signature]</i>
FINISHES	CHKD
MATERIALS	

Figure 31. Back Link Stop Valve Manifold Assembly

A



(51)

P.L. ISSUED

UNLESS OTHERWISE SPECIFIED DIMENSIONS ARE IN INCHES - 10 PERMANENT 1 PLACE DECIMALS ± 2 PLACE DECIMALS ± ANGLES ± FRACTIONS ± MATERIAL	SIGNATURES				GENERAL ELECTRIC PROCESSED BY SCHEMATIC STOP VALVE MANIFOLD ASM (EACH LINE) EXOSKELETON 4220703
	DATE	BY	CHKD	APP'D	
ALL SHEET	15	7	65		SIZE CODE IDENT NO D 4220703
					SCALE SHEET

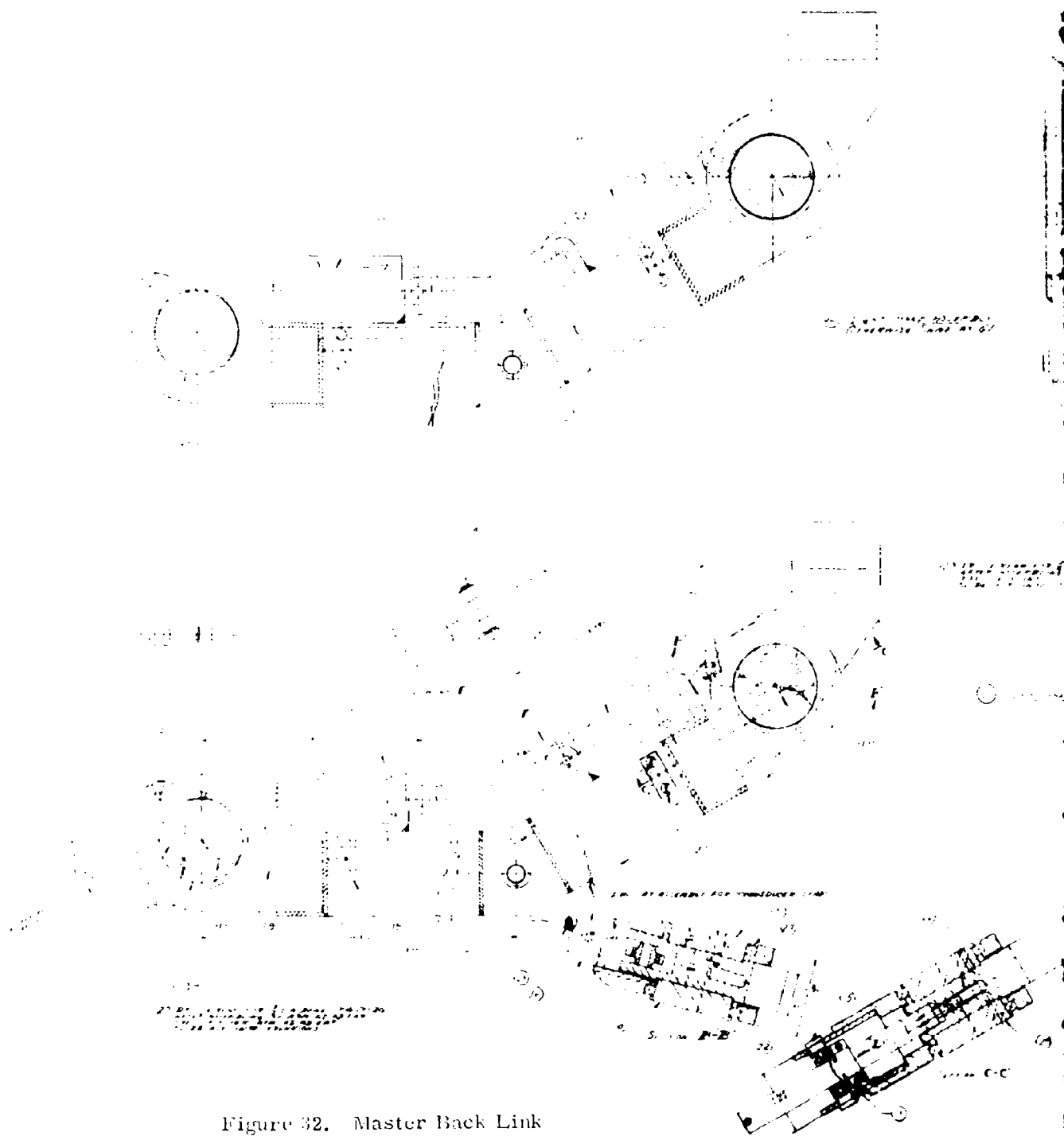
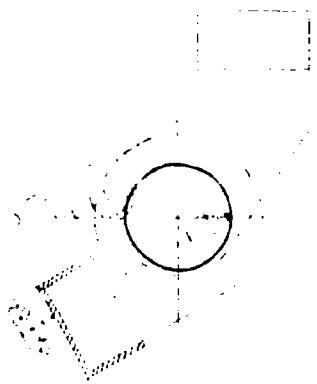
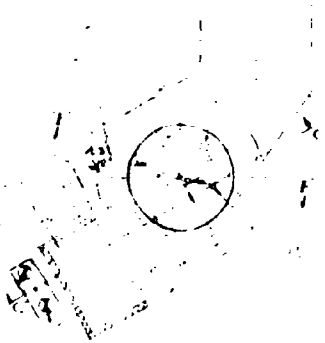
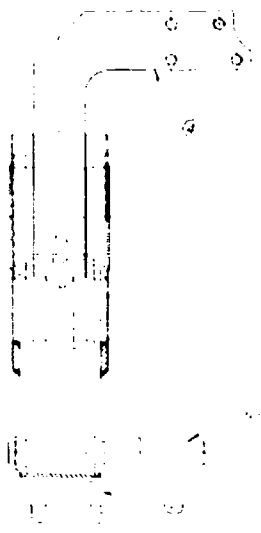

Figure 32. Master Back Link

A.



Reference to drawing
 Reference to drawing



Reference to drawing

Reference to drawing

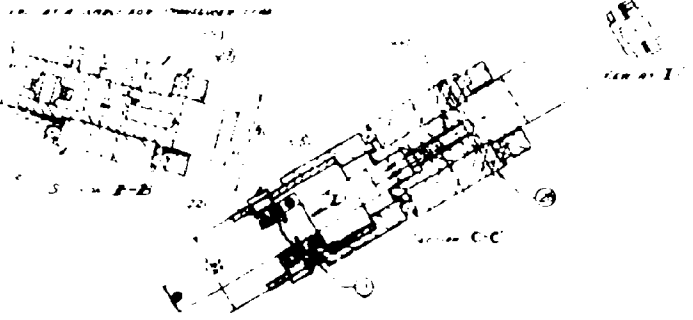
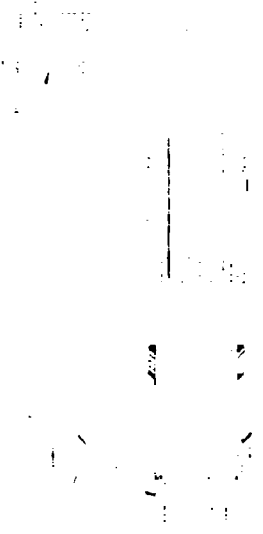

Reference to drawing

Reference to drawing

F.L. LANGE

DATE: 10/10/54 TIME: 1:00 PM DRAWING NO.: 587627 SHEET NO.: 1 TOTAL SHEETS: 1	CONTROL: [] CHECKED: [] APPROVED: [] DESIGNED: [] DRAWN: []	PROJECT: [] DRAWING TITLE: [] DRAWING NO.: 587627 SHEET NO.: 1 TOTAL SHEETS: 1
-------------------------------------------------------------------------------------------	------------------------------------------------------------------------------	----------------------------------------------------------------------------------------------

P.

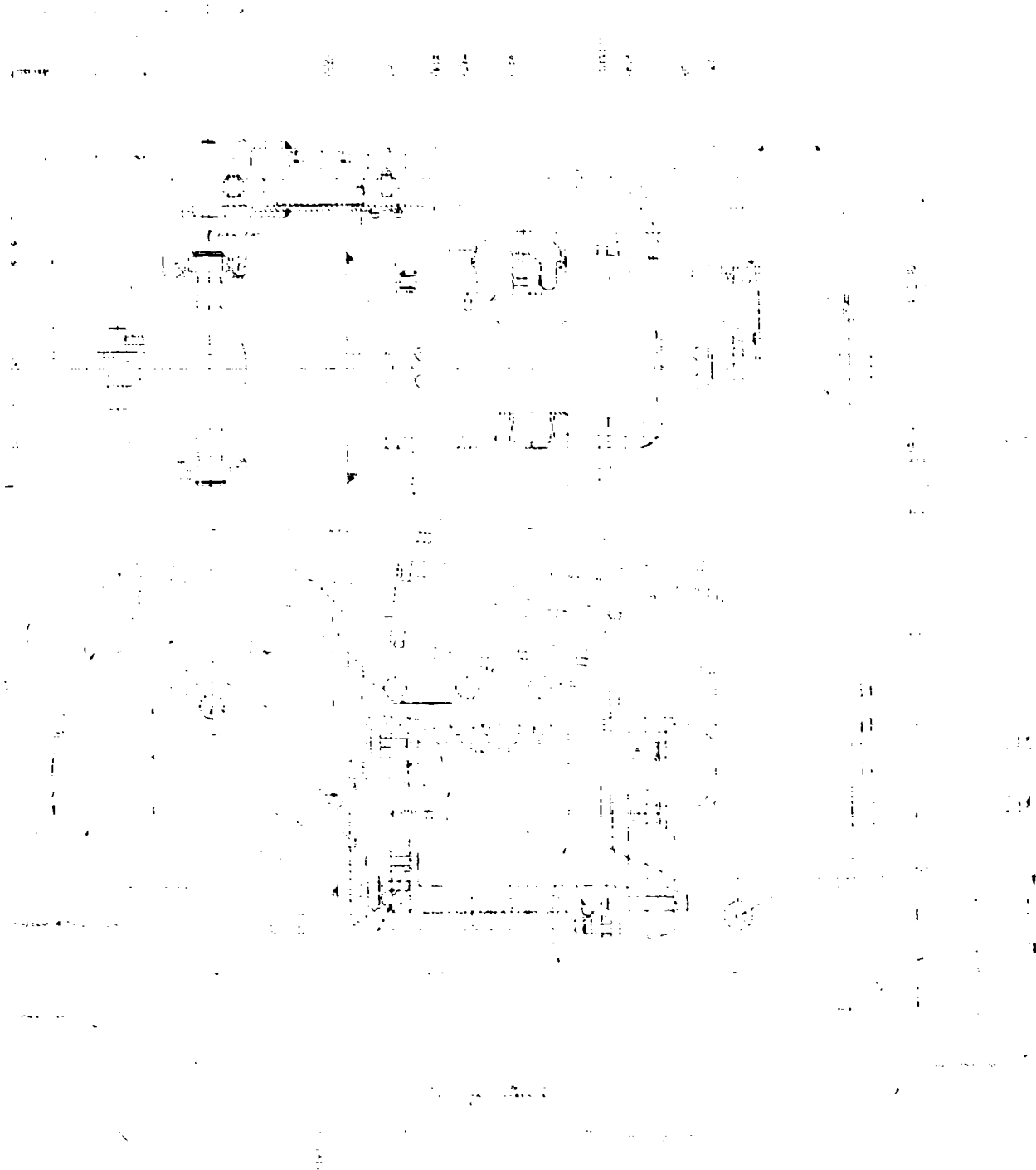

Figure 33. Upper Arm Assembly

A

1. TITLE 2. AUTHOR 3. PERIODICAL 4. NUMBER 5. DATE		6. SUBJECT 7. INDEXING		8. GENERAL INFORMATION 9. OTHER INFORMATION 10. COMMENTS	
11. CLASSIFICATION 12. SECURITY		13. STORAGE 14. LOCATION		15. DATE 16. TIME	
17. INDEXING 18. COMMENTS		19. STORAGE 20. LOCATION		21. DATE 22. TIME	

33. Upper Arm Assembly

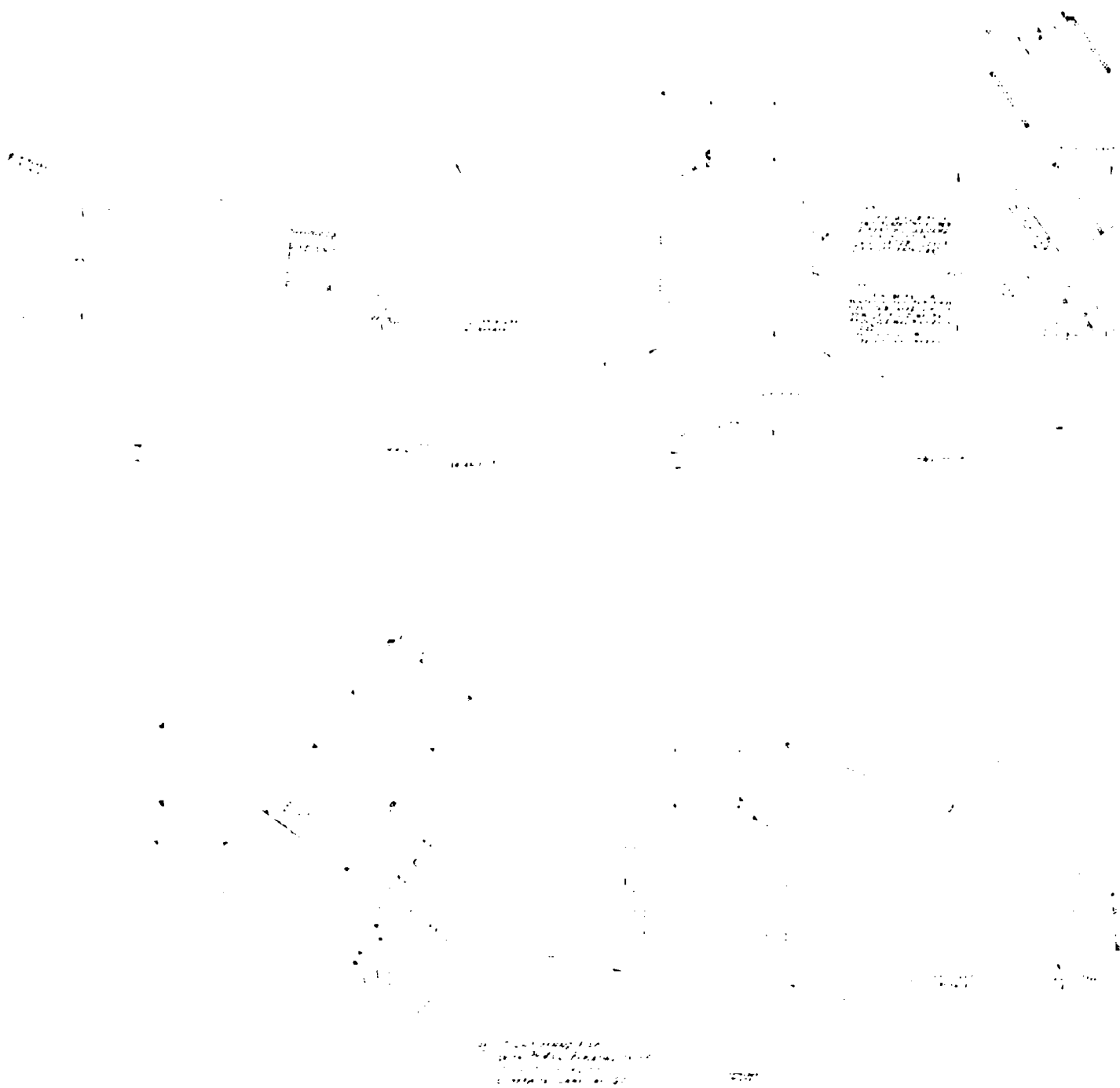
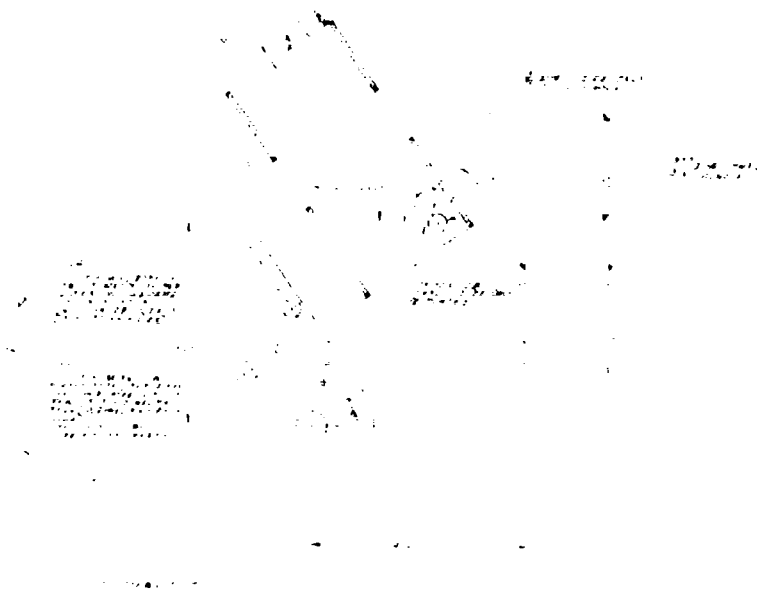

Figure 34. Upper Arm Master

A.



GENERAL REGISTER	
DATE	1954
TIME	10:30
LOCATION	...
OPERATOR	...
TESTER	...
RESULTS	...
REMARKS	...

Figure 34. Upper Arm Master

B.



Figure 35. Forearm and Hand - Top View

A.



GENERAL ELECTRIC	
PART NO. 587C634	
REV. 1	
E 587C634	
REV. 1	

Forearm and Hand - Top View

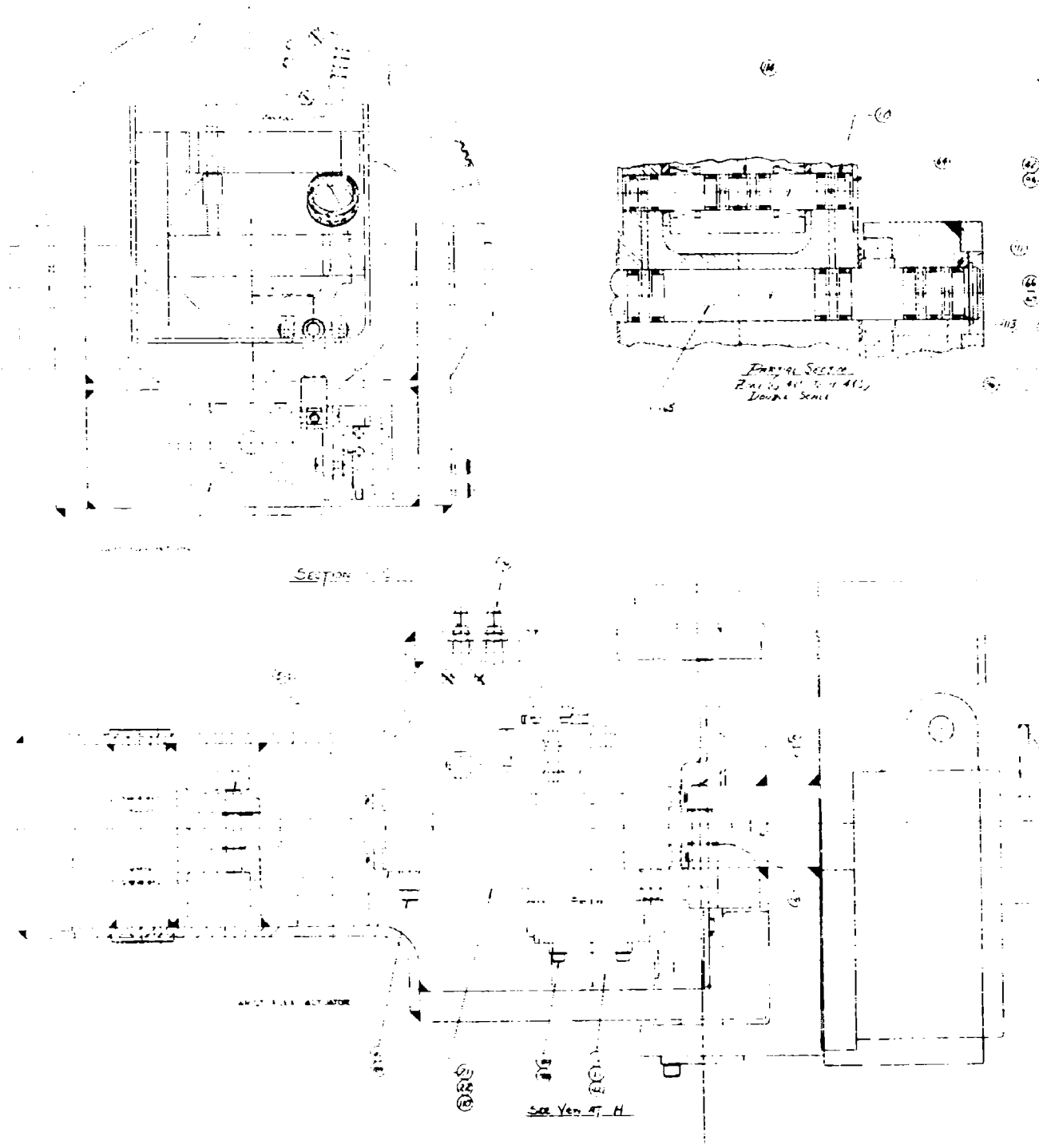
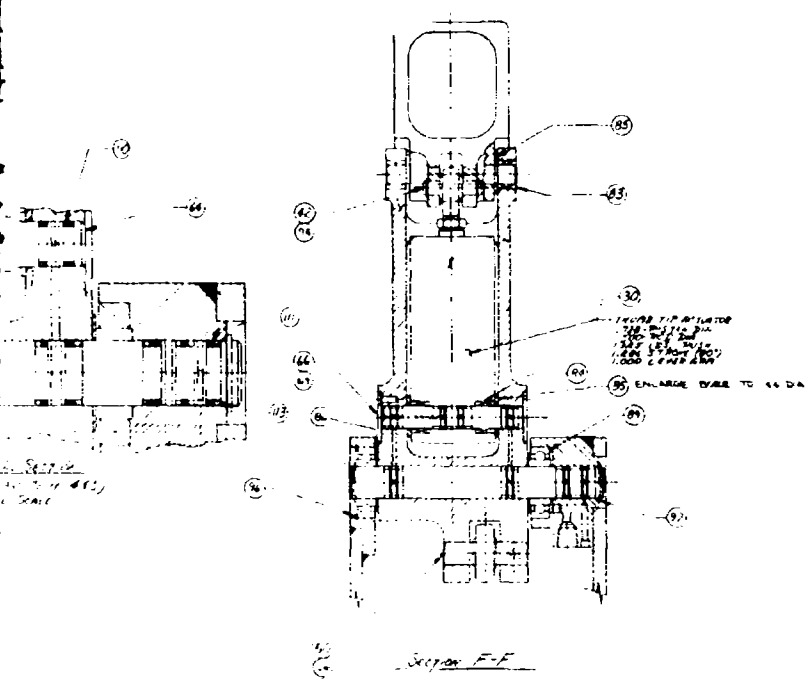
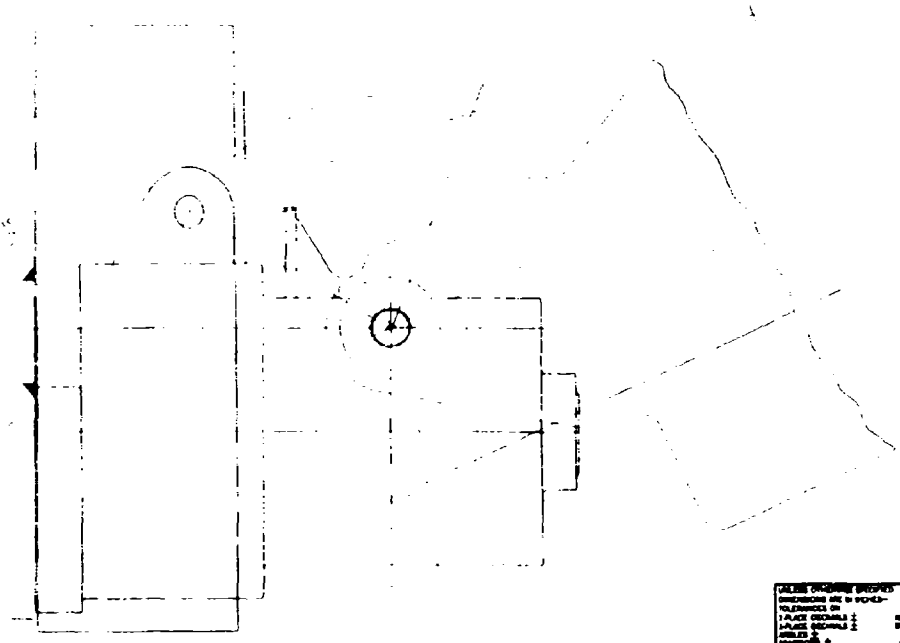

Figure 36. Forearm and Hand - Side



Section F-F



Forearm and Hand - Side View

ALL DIMENSIONS UNLESS OTHERWISE SPECIFIED DIMENSIONS ARE IN INCHES UNLESS OTHERWISE SPECIFIED UNLESS OTHERWISE SPECIFIED UNLESS OTHERWISE SPECIFIED UNLESS OTHERWISE SPECIFIED		GENERAL ELECTRIC 1200 N. 17TH ST. MILWAUKEE, WIS. 53233
PART NO. 587E634	TITLE FOREARM & HAND	DATE 1-15-64
DESIGNED BY E	CHECKED BY E	DRAWN BY E
APPROVED BY E	DATE 1-15-64	SHEET NO. 1 OF 4

Handwritten mark

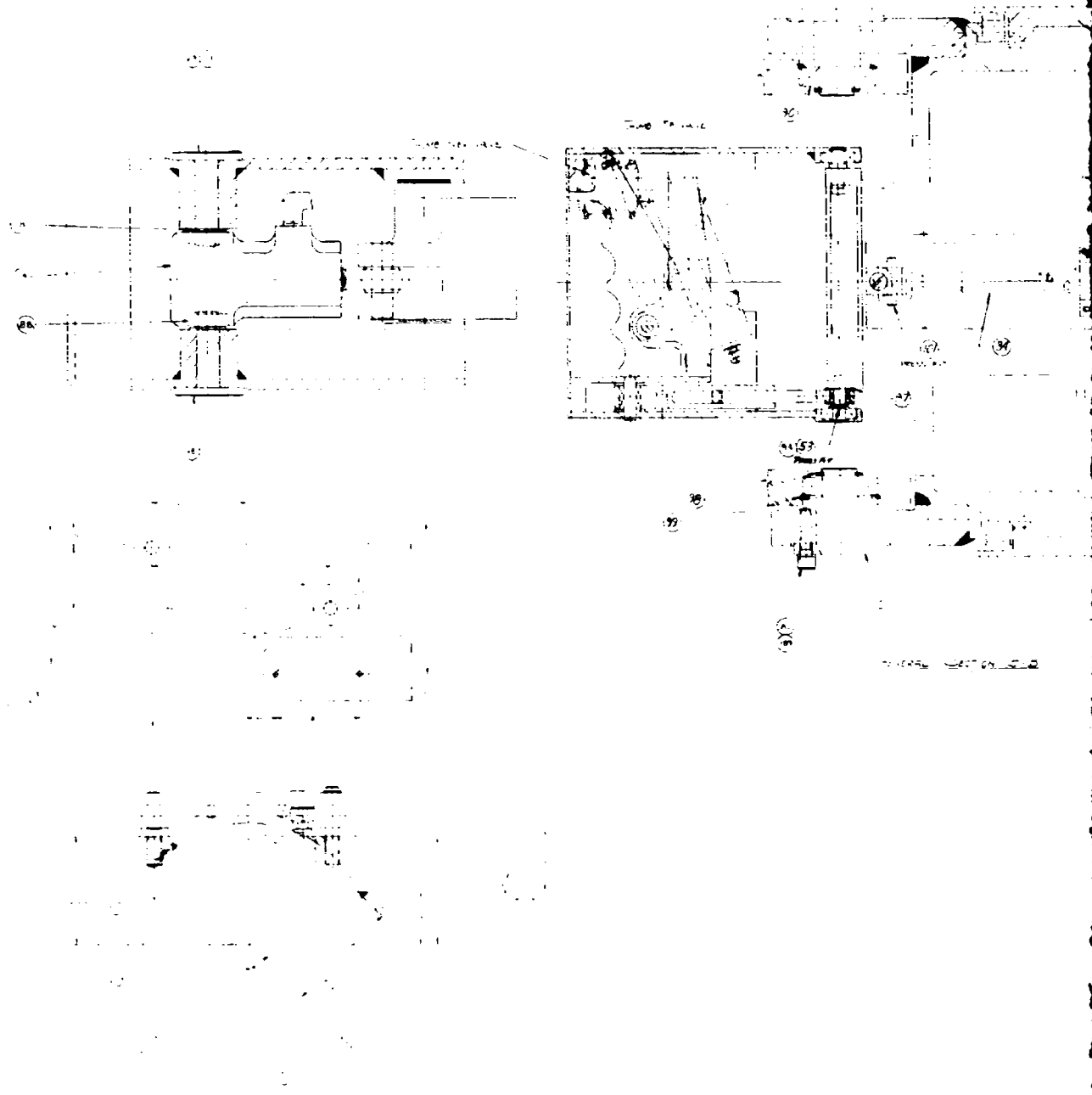

Figure 37. Master Forearm and Hand

11.

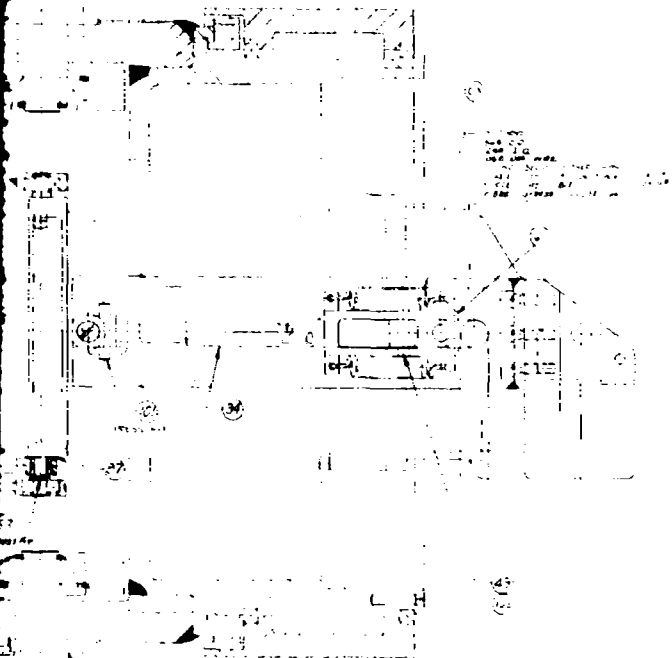

FIG. 1

CHECK OVERHAUL SPECIES OVERHAULS ARE IN BOXES: 1. ALL PARTS IN 2. PLACE OF ORIGINAL 3. PLACE OF ORIGINAL 4. PARTS IN 5. PARTS IN 6. PARTS IN	PART NO. 100	QTY. 1	UNIT EA	GENERAL ELECTRIC CAN. & INTL. CO.
	NAME FOREARM ASSEMBLY	DRAWING NO. 587E634	REV. E	PART NO. 587E634
	DATE 10/1/54	BY J. H. ...	CHECKED ...	APPROVED ...

Master Forearm and Hand

B.

SECTION 6

ARM SERVO DESIGN SUMMARY

INTRODUCTION

The electrohydraulic servos used in the exoskeleton arm system are of the bilateral (force reflecting) type. This type of servo differs from the ordinary unilateral servo in that either master or the slave may accept command signals resulting in a controlled response of the slave or master. The basic elements making up the bilateral servo used in the exoskeleton are:

- A servo valve that regulates a differential pressure, Δp , from a hydraulic pressure source in proportion to an input current, i .
- A hydraulic cylinder, slave "power" actuator, which converts the differential pressure, Δp , into a force which acts through the slave member to resist a load, F_S .
- A hydraulic cylinder, master "force feedback" actuator which converts the differential pressure, Δp , into a force which acts through the master control to apply a force to the operator proportional to and in the direction of F_S .
- A control circuit, consisting of a velocity and position error transducer package "tickler", a master tachometer and the associated electronics. The electronics are required to combine and condition the transducer signals so that when used as the control signal for the servo valve, a stable high performance control system results.

FUNDAMENTALS OF OPERATION

The operation of the bilateral servo used in the exoskeleton arm system can be understood by referring to the pictorial schematic of Figure 38. When a load force F_S is applied to the slave member, a desynchronization, x , from the equilibrium position will result between the master and slave member. This mechanical desynchronization is converted by the transducer "tickler" package to an electrical signal, e , which is conditioned by a compensation network and converted to a current used to control the servo valve. In addition to the error signal voltage, e , the error rate $\frac{dx}{dt}$, signal voltage, e_v , and master rate, $\frac{d\theta_m}{dt}$, signal voltage, e_m , are used as auxiliary control signals to the servo valve to achieve the desired dynamic response and stability characteristics. In response to the input current, i , the servo valve produces a controlled differential pressure output, Δp , which acts across the piston of the slave "power" actuator in the proper sense as to produce a restoring force which resists the applied load force, F_S , and reduces the desynchronization (error signal) to a small final (steady-state) value. This steady-state value is achieved when the force being generated by the slave "power" actuator just balances the load force, F_S .

The tendency of a control to minimize the system error signal is a characteristic of feedback control systems. The distinguishing characteristic of the exoskeleton bilateral servo is that the differential servo valve pressure, Δp , also acts across the piston of a "force feedback" actuator. This actuator applies a

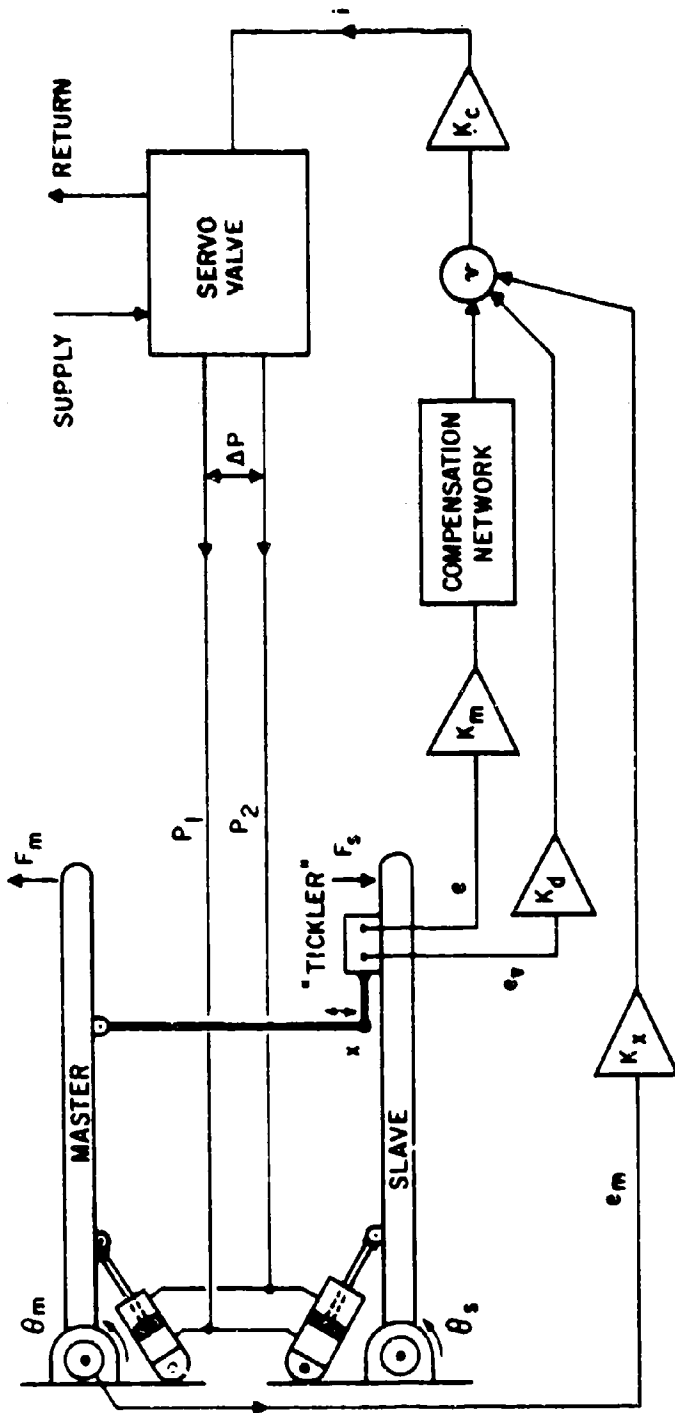

Figure 38. Single Joint Pictorial Schematic

force to the operator through the master control, proportional to and in the same sense as the force, F_s , applied to the slave member. Thus, the operator "feels" a portion of the load force encountered by the slave.

The "bilateral" characteristic of the exoskeleton arm servos can be considered from another point of view. A force, F_m , applied to the master control will cause a counterclockwise rotation. This results in a desynchronization, x , between the master and slave that results in a change in the error signal from the transducer package "tickler". This change in error signal produces a change in the differential pressure output of the servo valve, which acting across the slave "power" actuator, causes the slave member to accelerate in counterclockwise direction and minimize the error signal by following the master control. Conversely, if a force, F_s , was applied to the slave member and the master was unconstrained, the slave would rotate in the clockwise direction, and the master would follow the slave.

SERVO DESIGN PHILOSOPHY - JOINTS-IN-SERIES

The design and optimization of high performance cascaded bilateral servos as used in the exoskeleton arm has shown itself to be an awesome task. Considerable effort has been expended in this area in an attempt to obtain economical and reliable methods for designing and optimizing servo systems of this type. This continuing effort includes extensive investigations of system performance and stability characteristics on both the analog and digital computer and the application of advanced control theory methods in stability studies.

The results of a large part of this effort has been reported in a special technical report on joints-in-series, 10 June, 1968.

In this report, a general recommendation as to the form of the compensation network to be used in the exoskeleton arm servos has been made. This recommendation was an interpolation of findings in the study of the unilateral joints-in-series case and the single joint bilateral case. It was further substantiated by an extensive analog computer simulation for the case of three bilateral servos in series.

Time did not permit a full scale computer simulation of the entire exoskeleton arm system for the purpose of designing and optimizing the individual joints. It was, therefore, necessary to make some simplifying assumptions that would permit the efficient determination of an "approximate" solution to parameters required for an optimum control. By providing a sufficient range of adjustment on each of the pertinent control parameters, "optimization" can be completed on the machine itself.

The method of making control parameter calculations on simplified models has shown itself sufficiently accurate in the past when used in the design of other bilateral servos, or when compared to full scale computer simulations to warrant considerable merit.

DYNAMIC MODEL - EXOSKELETON BILATERAL SERVO

The general form of the frequency compensation networks used in the design of the individual exoskeleton joint servos parallels the recommendations of the special report issued on joints in series. The form of the feed forward compensator, $G_c(s)$, is:

$$G_c(s) = \frac{K_v}{(1 + K_g)} + \frac{K_v K_g}{(1 + K_g)(1 + T_L S)} + K_v K_d S$$

Velocity feedback is used on each of the joints of the master control.

The signal flow diagram which is common to each joint in the exoskeleton arm system is shown in Figure 39.

The assumptions and simplification made in deriving this model were:

- 1) The intercoupling effects between the individual servos due to joints-in-series will not be considered.
- 2) A linearized model of the physical system will be used (i.e. friction, hysteresis, saturation, etc. is neglected).
- 3) Structural resonances will not be included in the analysis, bandwidth will however be limited in order to justify the simplification.
- 4) The inertia seen at the individual joints will be calculated by treating all joints as rigid members.
- 5) Component lags occurring at frequencies greater than 100 Hz are neglected.

It is believed that the use of an inertia that is obtained by assuming all servo joints are infinitely rigid is very conservative and merely represents an upper bound. It is, therefore, very likely that the amount of velocity feedback required to obtain a stable servo will be less than calculated in the analysis.

SYMBOLS

<u>Symbol</u>	<u>Description</u>	<u>Units</u>
B	The effective bulk modulus of the hydraulic fluid and lines (100,000 psi)	lbs/in ²
I _{mt}	The total inertia about a master joint due to supported structure.	lb. in. sec ²
I _{st}	The total inertia about a slave joint due to supported structure.	lb. in. sec ²
K _c	Power amplifier gain	v/v
K _d	"Tickler" velocity error network gain	v/v
K _g	Branch gain of lag network	v/v
K _L	"Tickler" linkage gain	in/in
K _m	Main amplifier gain	v/v
K _p	Servo valve pressure feedback gain	cis/psi
K _v	"Tickler" velocity transducer gain	v/in/sec
K _{v_x}	Master velocity transducer gain	v/in/sec
K _x	Master velocity transducer amplifier gain	v/v
N	Gear ratio of torque motor	
p	Linearized differential pressure	lb/in ²
P _s	Supply pressure	psi
q	Linearized flow	in ³ /sec.
Q _c	Servo valve flow gain	cis/amp.
R ₁	Valve coil resistance	ohms
r _m	The effective crank radius on which the master velocity transducer operates	in.
R _t	The distance between a joint and the tickler input lever controlling that joint	in.
S	La Placian operator $\frac{d(\)}{dt}$	sec ⁻¹
T ₁	Servo valve time constant	-sec.

SYMBOLS (continued)

<u>Symbol</u>	<u>Description</u>	<u>Units</u>
T_L	Lag network time constant	
T_m	Applied operator torque	in-lbs.
T_s	Applied load torque	in-lbs.
V_T	Total entrained volume of oil	in ³
x	Desynchronization between master and slave at radius R_t .	- inches
θ_m	Angular position of master control	radians
θ_s	Angular position of Slave	radians
$\dot{\theta}_m$	The product of the average piston area and the effective crank radius for a master joint.	in ³ /(sec.-rad.)
$\dot{\theta}_s$	The product of the average piston area and the effective crank radius for a slave joint	in ³ /(sec.-rad.)

PERFORMANCE CHARACTERISTICS OF A BILATERAL SERVO

Certain performance characteristics of bilateral servos have been identified and found to bear significantly on the suitability of a control for a specific application. Some of the more important of these characteristics, their definitions, and how they are derived for the type of bilateral control used in the exoskeleton are discussed in the following section.

Definitions of Servo Performance Terms

A performance parameter, which becomes very important when the mechanical clearances between the slave and master control are limited, is the servo "stiffness" or compliance which is defined as:

Compliance -- The steady-state rate of deflection of a joint under load.

i.e. radians/inch-lb.

It is sometimes more convenient to express compliance as a percent in which case a new term is defined.

Percent Compliance Error (E_C) -- The steady-state desynchronization required between master and slave to generate full slave torque at zero velocity expressed as a percent of 90° slave stroke.

A performance parameter which is of equal importance when the mechanical clearances between the master and slave is limited is the servo "slew error" which is defined as:

Slew Error -- The steady state desynchronization required between master and slave to sustain a constant velocity.

Again, it is sometimes more convenient to express slew error as a percent in which case a new term is defined:

Percent Slew Error (E_V) -- The steady-state angular desynchronization required between master and slave to sustain a constant velocity of 90 degrees/sec. at no load expressed as a percent of 90 degrees slave stroke.

An important servo performance parameter, which relates to operator fatigue and the accuracy of the force feedback signal, is the slew drag of a bilateral servo. This term is normally defined as follows:

Slew Drag -- The force or torque required in a bilateral servo to drive the master control, that is approximately proportional to velocity.

It is important that this term be kept as small as possible in order to prevent operator fatigue and minimize the distortion of the force feedback.

It is worthwhile to note that the bilateral servo scheme used in the exoskeleton has the theoretical minimum slew drag of any type electrohydraulic bilateral servo. With this type of bilateral control, the only components of slew drag that are present are the dynamic seal friction in the actuators and the viscous hydraulic forces of the fluid. It is anticipated that these will be negligible.

Derivations of Servo Performance Equations

The performance characteristics discussed in the preceding section can be related to the servo parameters of the bilateral control by a set of equations. The development of these relationships is the topic of discussion in this section. These relationships will be derived by applying the appropriate boundary conditions and constraints to the equations represented by the "signal flow" diagram of Figure 39.

To determine the compliance of the control, the steady-state relationship between $\Theta_m \Theta_s$ and slave torque T_s , must be established. A convenient method for accomplishing this is to ground the master control, i.e. $I_m \rightarrow \infty$, mathematically force the slave position function $\Theta_s(t)$ to conform to a step input function of magnitude Θ and write the La Place transform of the differential equation relating the change in slave position to the change in slave torque. The resulting relationship is:

$$T_s(S) = \frac{\Theta}{S} \left[\psi_s S + R_t K_L K_v K_d S + \frac{R_t K_L K_y}{1 + K_g} \left(1 + \frac{K_g}{(1 + T_L S)} \right) \right] \dots$$

$$\frac{K_m K_c Q_c \psi_s}{R_1 K_p \left(S^2 \frac{T_I V_T}{2K_B} + S \frac{V_T}{2K_B} + 1 \right)}$$

Applying the final value theorem to the preceding equations yields the steady-state relationship between slave torque and the desynchronization between the master and slave.

$$\lim_{S \rightarrow 0} S T_s(S) = \frac{-R_t K_L K_y K_m K_c Q_c \psi_s}{R_1 K_p} = T_s \text{ (final)}$$

Then:

$$\text{Compliance} = \frac{T_s}{\Theta_m - \Theta_s} = \frac{T_s}{\Theta} = \frac{-R_t K_L K_y K_m K_c Q_c \psi_s}{R_1 K_p}$$

and if $T_s \text{ (final)} = T \text{ max.} = P_s \psi_s$

$$\text{Percent Compliance Error } (E_c) = \frac{\Theta_m - \Theta_s}{1.57} \cdot 100 = \frac{-P_s R_1 K_p 100}{v_t K_L K_y K_m K_c Q_c 1.57}$$

To determine the slew error of the control, the steady-state relationship between the master and slave velocity and the desynchronization, x , must be established. A convenient method of determining this relationship is to assign the desired steady-state velocity to the master and slave, along with the appropriate boundary conditions, and solve for the required desynchronization. For a steady-state velocity of 90 degrees/sec. of master and slave, the following relations are required. Reference, Figure 39.

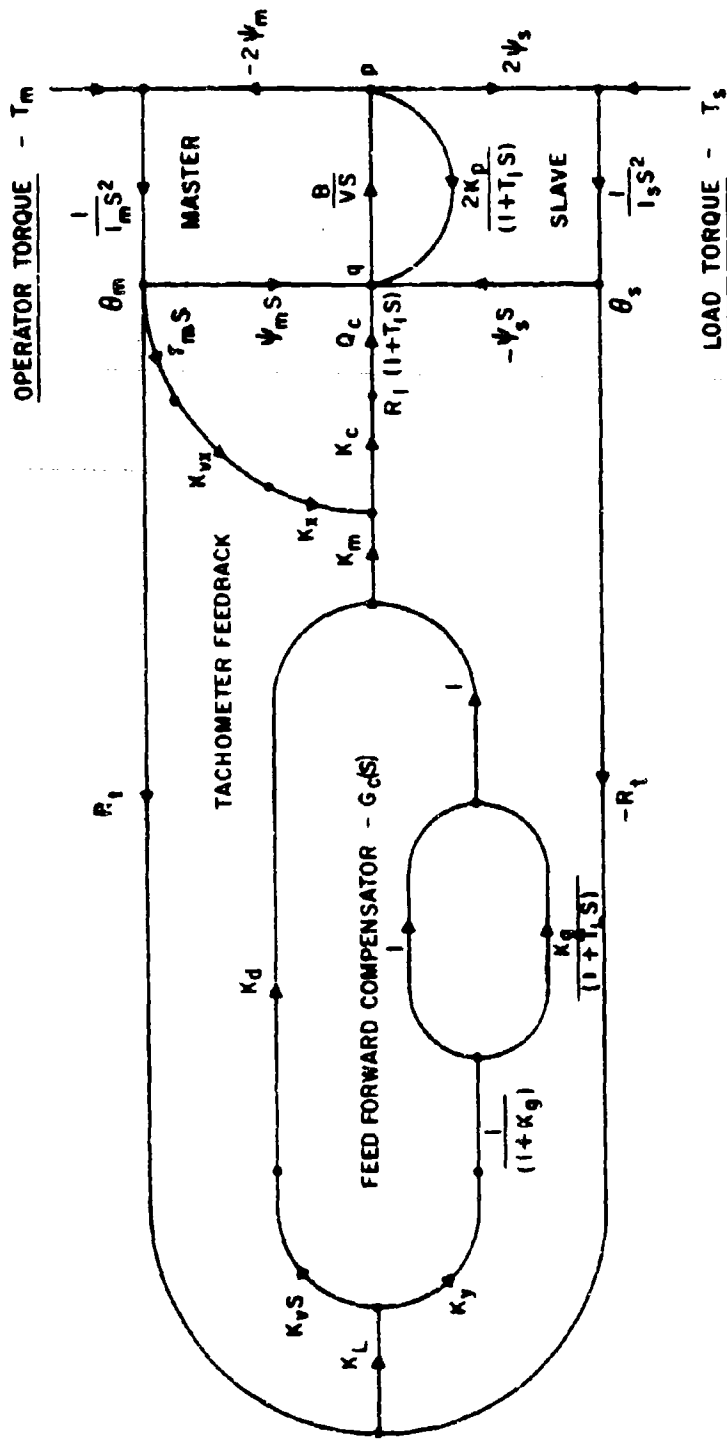

Figure 39. Signal Flow Diagram

$$1) \frac{d\theta_m}{dt} = S C_m = \frac{d\theta_s}{dt} = S \theta_s = 1.57 \text{ rad/sec.}$$

$$2) \frac{dx}{dt} = S x = 0$$

$$3) p = 0$$

Relation No. 2 follows from the fact that if master and slave are slewing at the same velocity, then the error signal, x , must be a constant.

Relation No. 3 follows from the fact that if the master and slave are slewing at the same constant velocity, then the torque applied to the master and slave must equal zero; hence, the pressure p equals zero. Note the linearized model contains no gravity loads.

With the preceding boundary conditions and the conservation of flow requirement at node 8, the steady-state flow balance equation can be written as:

$$\frac{x K_L K_y K_m K_c Q_c}{R_1} = \frac{dC_m}{dt} \left(\psi_m + \frac{r_m K_{vx} K_x K_c Q_c}{R_1} \right) + \frac{d\theta_s}{dt} \psi_s$$

Substituting

$$R_t (\theta_m - \theta_s) = x \text{ and } \frac{d\theta_m}{dt} = \frac{d\theta_s}{dt} = C$$

The equation for slew error is then:

$$\theta_m - \theta_s = C \left(\psi_s - \psi_m - \frac{r_m K_{vx} K_x K_c Q_c}{R_1} \right) \frac{R_1}{K_L K_y K_m K_c Q_c R_t}$$

and for $C = 1.57 \text{ rad/sec.}$ the equation for percent slew error is:

$$\text{Percent Slew Error } (E_v) = \frac{(\theta_m - \theta_s)}{1.57} \cdot 100 = \left(\psi_s - \psi_m - \frac{r_m K_{vx} K_x K_c Q_c}{R_1} \right) \frac{R_1 \cdot 100}{K_L K_y K_m K_c Q_c R_t}$$

Performance Characteristic Tabulation

The following table is a tabulation of the calculated performance parameters of each joint in the exoskeleton arm system. These values were obtained by using the equations derived in the preceding section and the servo parameter contained in Table II.

TABLE I

Joint	Performance	
	% Compliance	% Slew Error
Wrist Flex	-2.1%	+5.6%
Elbow Flex	-2.96%	+0.014%
Forearm Rotate	-2.23%	+0.35%
Upper Arm Rotate	-1.95%	+2.2%
Shoulder Flex	-1.9%	+0.3%
Back Flex	-2.06%	+0.44%
Arm Ab/Ad	-2.0%	+2.2%

STABILITY ANALYSIS

Stability analysis of the exoskeleton servos is based on Bode and Nyquist methods and the linear model represented in the signal flow diagram of Figure 39. To simplify the analysis, the signal flow diagram of Figure 39 was reduced to the more convenient form shown in Figure 40 where the constants have been redefined as follows:

$$K_1 = \frac{\psi_m^2}{I_m} + \frac{\psi_m R_t K_L K_v K_d K_m K_c Q_c}{I_m R_1}$$

$$K_2 = \frac{\psi_m r_m K_x K_{v_x} K_c Q_c}{I_m R_1}$$

$$K_3 = \frac{\psi_s^2}{I_s} + \frac{\psi_s R_t K_L K_v K_d K_m K_c Q_c}{I_s R_1}$$

$$K_4 = \frac{K_L K_y R_t K_m K_c Q_c}{R_1} \left(\frac{\psi_m}{I_m} + \frac{\psi_s}{I_s} \right)$$

$$T_c = \frac{T_L}{K_g}$$

$$T_3 = T_L$$

$$\omega_n^2 = \frac{2 K_p B}{T_1 V_t}$$

$$2\zeta/\omega_n = \frac{V_t}{2K_p B}$$

While the form of the signal flow diagram of Figure 40 does not retain the same physical significance at each node as the signal flow diagram of Figure 39, they are equivalent from a stability standpoint.

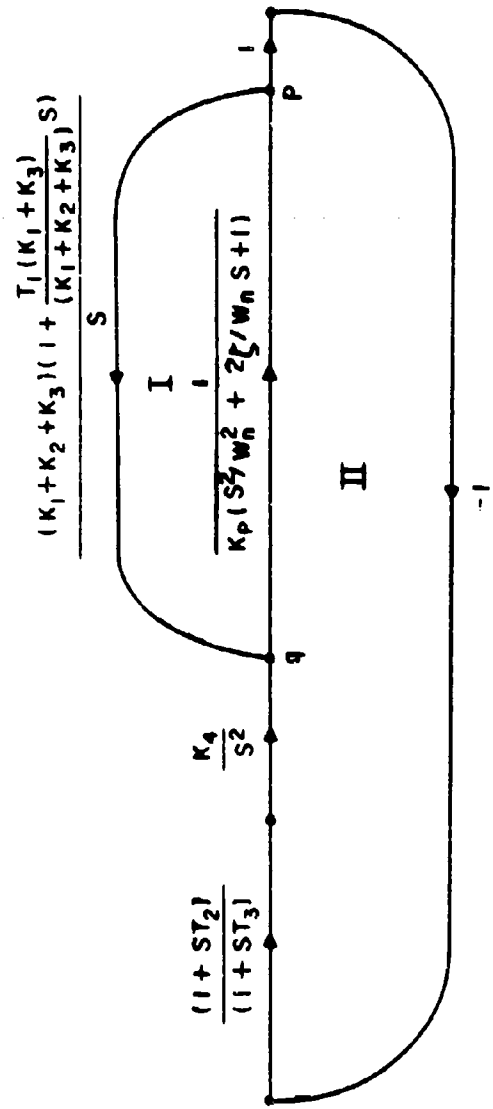

Figure 40. Reduced Signal Flow Diagram

TABLE II

EXO - SERVOSSERVO DESIGN PARAMETERS

Joint: Parameter	Wrist Flex	Forearm Rotate	Elbow Flex	Upper Arm Rotate	Shoulder Flex	Back Flex	Arm AB-AD
K_g (v/v)	12	9	9	9	12	12	9
K_d (v/v)	.25-2.5 0*	.25-2.5 0*	.25-2.5 0*	.25-2.5 0*	.25-2.5 0*	.25-2.5 0*	.25-2.5 0*
T_L (sec.)	1-8 2*	1-8 4.5*	1-8 2*.65	1-8 4.0*	1-8 5*	2-16 8*	2-16 10*
K_m (v/v)	1.0-10 3.73*	.4-4.0 .84*	.4-4.0 1.6*	.4-4.0 1.5*	.4-4.0 1.24*	.4-4.0 1.3*	.4-4.0 1.1*
K_c (v/v)	1	1	1	1	1	1	1
K_y (v/v)	1-10 8.1*	.05-.5 .136*	1.5-15 5.9*	.1-1 .35*	1-10 3.5*	1.5-15 5.3*	1-10 2.69
K_v (v.sec/in)	.12	.12	.12	.12	.12	.12	.12
K_y (v/in)	90	90	90	90	90	90	90
K_{vx} v. sec/in or (v.sec/rad)	.12	(.925)	.09	(1.62)	.5	.5	.5
K_L (in/in)	.17-.026 .1*	1.906 (in/rad)	.12-.086 .1*	1.44* (in/rad)	.167*	.158*	.44*

* Denotes Design Values

TABLE II (continued)

Exo - Servos
Servo Design Parameters

Joint: Parameter	Wrist Flex	Forearm Rotate	Elbow Flex	Upper Arm Rotate	Shoulder Flex	Back Flex	Arm AB-AD
Q (in ³ /sec. amp)	10,000 No Load	10,000 No Load	10,000 No Load	10,000 No Load	10,000 No Load	10,000 No Load	10,000 No Load
K _p (cis/psi)	.04-.08	.04-.08	.04-.08	.04-.08	.04-.08	.04-.08	.04-.08
ψ _m (in ³ /rad.)	.04-.06	.00385	.195-.255	.12	.416-.59	.575-. .815	.11-.176
ψ _s (in ³ /rad.)	3.4-4.2	1.5	7.4-9.7	4.3	10.4- 14.8	14.4- 20.4	2.88- 4.52
I _m (lb-in-sec ²)	.283	.087-.174	2.15-2.66	2.8-6.2	11-19.6	23-52	4.3-.49
I _s (lb-in-sec ²)	11.4-349	3.4-980	32-1053	19-2564	120-3074	181-5259	35.3- 6520
V _t (in ³)	6.5	6.1	16	6.3	27.7	38	6
R _t (in)	4.7-6.7	--	7.94-9.94	--	10.25	10	4.34
r _m (in)	.56	--	.8	--	.674	.674	3.125
T ₁ (sec.)	.016	.016	.016	.016	.016	.016	.016
B (lb/in ²)	100,000	100,000	100,000	100,000	100,000	100,000	100,000
N	1	4.62 Master (Actuator & Tach.)	1	8.1 Master Tach.	1	1	1

A tabulation of the parameter values to be used with this form of the signal flow diagram was made for each joint of the exoskeleton. For each joint, the tabulation was made to include the appropriate maximum and minimum "linearized" values for both the load floating and slave grounded modes. As an example, the tabulation used for the wrist flex servo is presented in Table III. The values used in calculating the parameters for this table were obtained from Table II.

TABLE III

Wrist Flex Servo Analysis Parameters

Parameter	Master and Slave Floating		Slave Grounded	
	Maximum	Minimum	Maximum	Minimum
K_1	.013	.006	.013	.006
K_2	1.4	1.4	1.4	1.4
K_3	1.55	.033	0	0
K_4	4450	127	1650	127

$$\omega_n^2 = 770 \times 10^2$$

$$2\zeta/\omega_n = .813 \times 10^{-3}$$

$$T_1 = .016$$

$$T_2 = .16$$

$$T_3 = 2$$

The reduced signal flow diagram of Figure 40 was then put into a digital computer program called "Nyplot", and the frequency response characteristics of loops I and II were examined to check stability for each set of parameters in Table II for each joint.

The results of these computer runs for a single joint (the wrist flex) are shown in the Bode plots of Figures 31-34.

Servo parameters were, in general, adjusted to obtain minimum compliance and slew error and a position error loop (II) bandwidth between 1 - 10 Hz.

In general, the phase margin of the position error loop was kept between approximately $25^\circ - 40^\circ$. In order to maintain this much phase margin in the maximum inertia-load floating case, a large amount of master velocity feedback is required. This results in a condition in loop I where, because of the high gain, very little phase margin exists for the minimum inertia-load floating case.

It, therefore, may be necessary to reduce the master velocity feedback gain K_x , if high frequency instability occurs.

This may result in some degradation in control performance, but it is believed that because of the conservative manner in which the slave inertia has been calculated (i.e. all servo joints assumed infinitely rigid connections), considerably less velocity feedback will be required than calculated, and actual performance will not be significantly affected by reasonable changes in the value of K_x .

The electronic control package has been designed with the approximations of the analysis in mind, and a generous range of adjustments has been provided for the parameters K_m , K_d , K_x , and T_L .

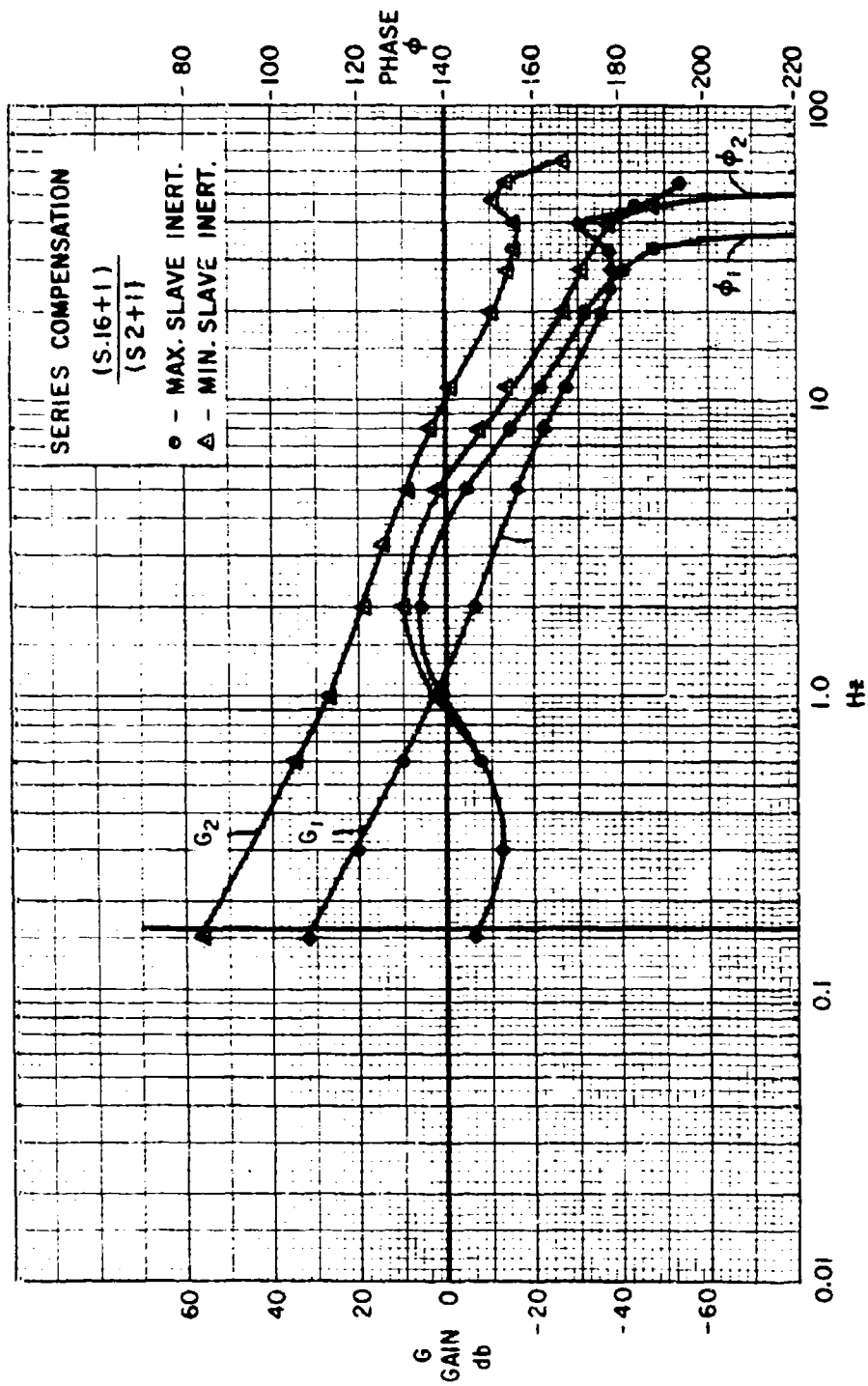

Figure 41 - Wave Fics
 Outer Loop 1:
 Master and Slave Floating

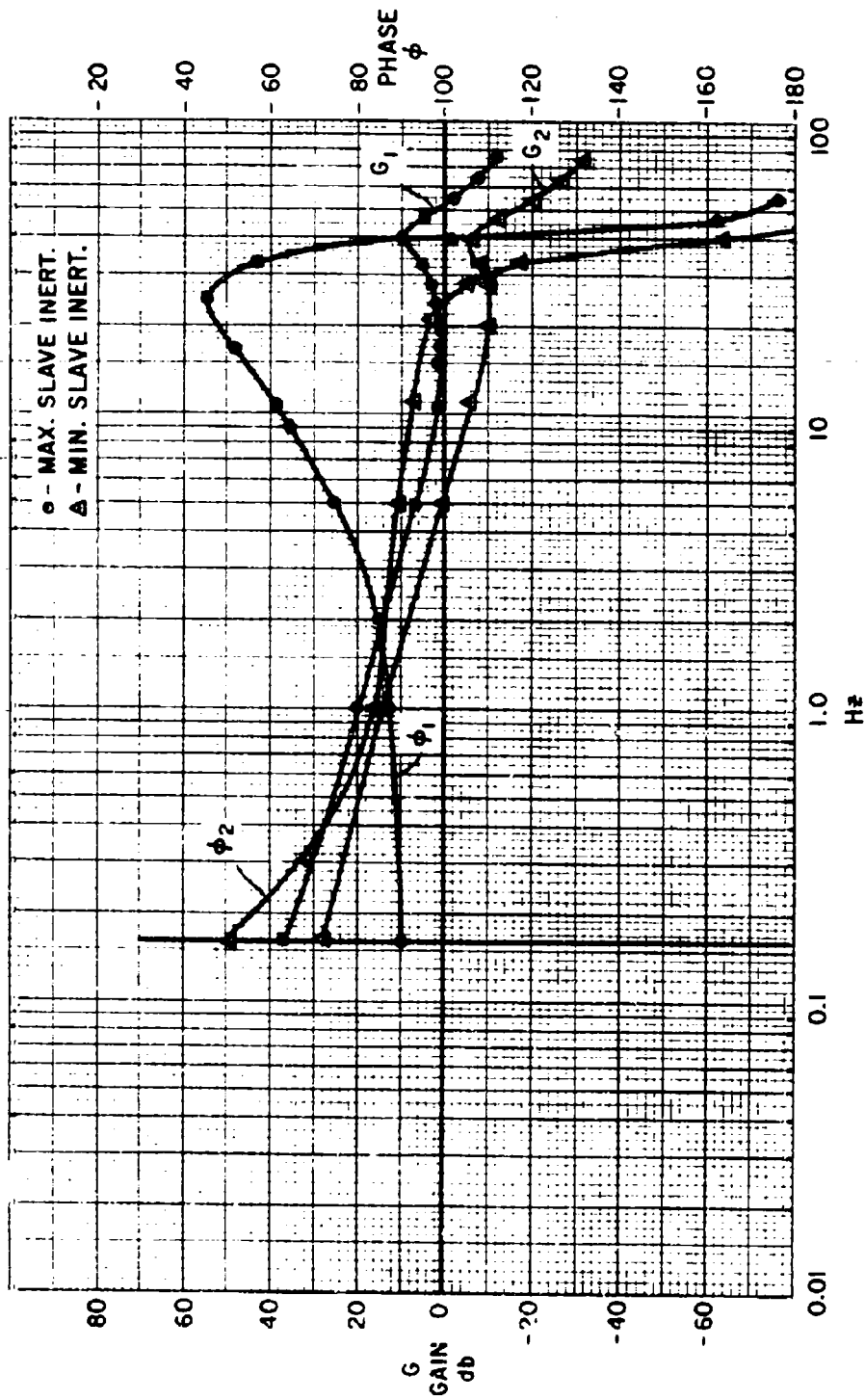

Figure 42. Wrist Flex
 Inner Loop I
 Master and Slave Floating

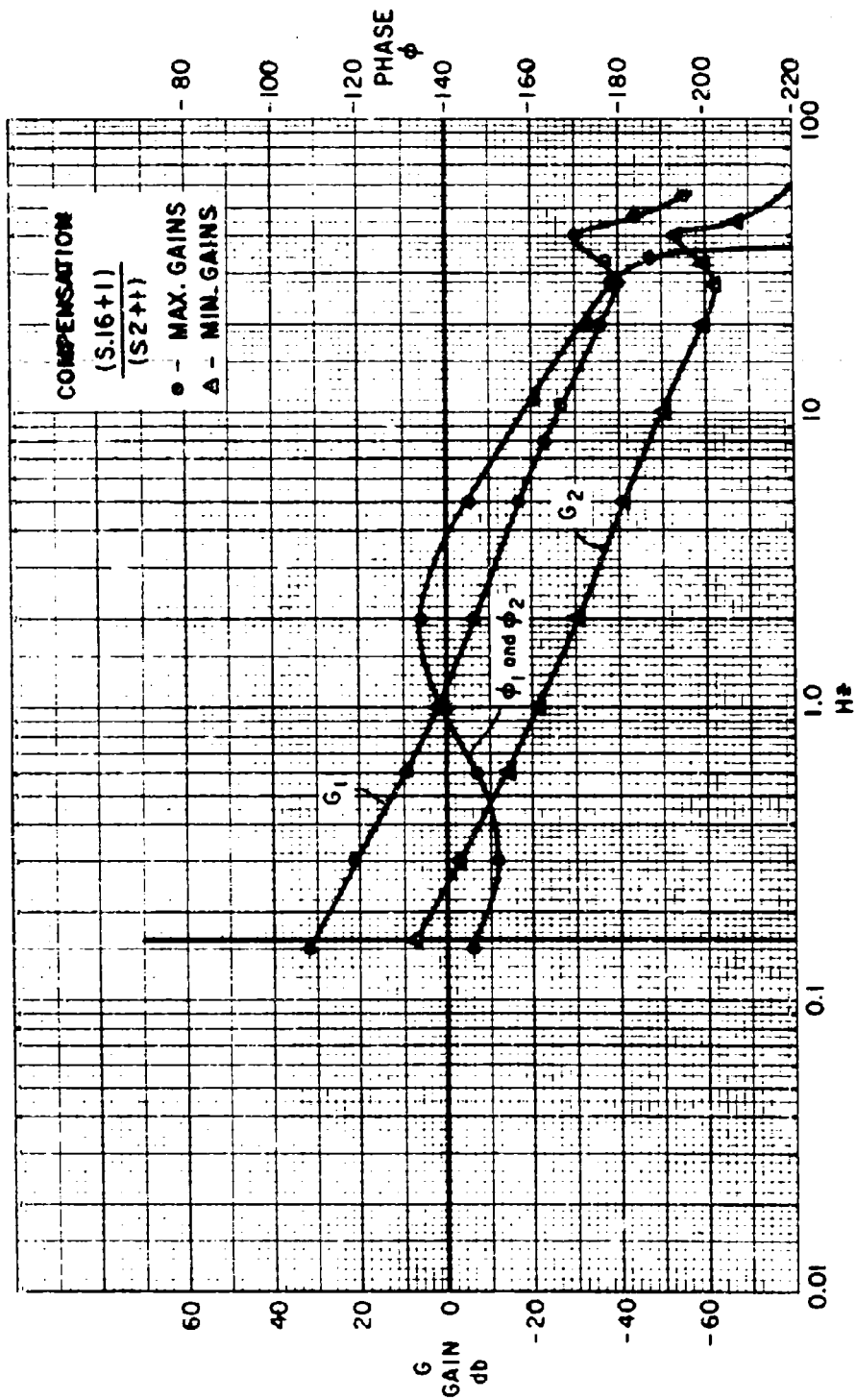

Figure 43 Wrist Flex
Outer Loop-II
Slave Grounded

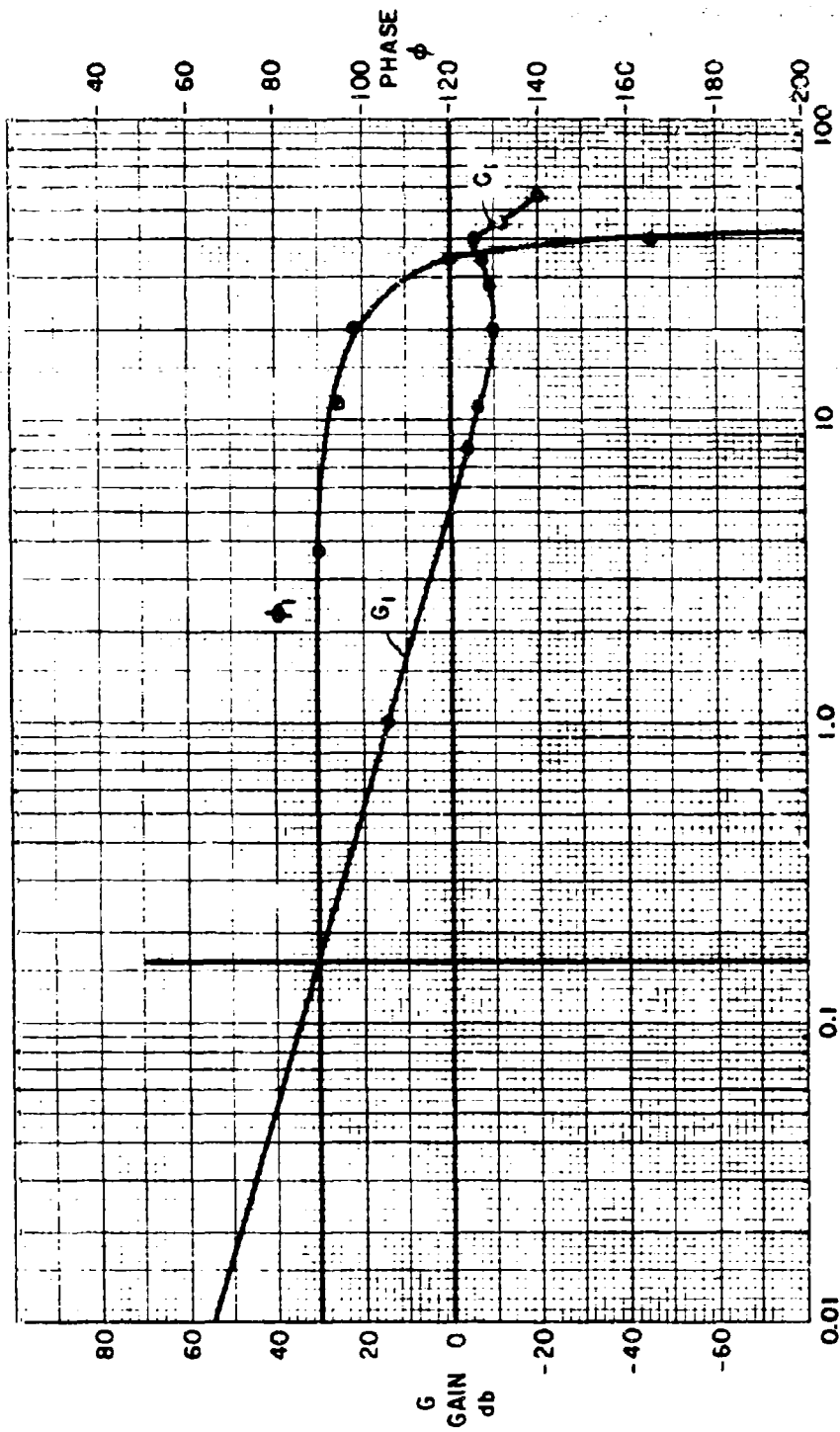

Figure 44 Wrist Flex
inner Loop-1
State Grounded

CORRELATION OF OBSERVED RESULTS

Joint Simulator

Test results obtained on the joints simulator, Figure 5, have demonstrated the adequacy of the control design used in the exoskeleton arm system. A full scale breadboard simulation of a joint equivalent to the exoskeleton shoulder joint on the joint simulator demonstrated that the control scheme was more than adequate from all standpoints. Compliance of the breadboard servo was measured and found to be 2%; slew error was less than 1%; and the bandwidth of approximately 1 Hz for maximum inertia resulted in a dynamic response that was more than adequate. Force feedback quality of the control was found to be excellent, particularly the high frequency content of the contact forces which were transmitted directly from the slave cylinder through the oil to the master control. The dynamic compliance characteristic of the control was also subjectively evaluated by a number of people and found to be acceptable for the exoskeleton application.

Exoskeleton Wrist Test

A full scale checkout of the exoskeleton wrist servo was recently completed using the actual exoskeleton hand and a supporting test fixture, Figure 12. The results of the tests on this single exoskeleton joint were extremely encouraging. Using the calculated servo parameters contained in the preceding sections, only a minor adjustment to the master velocity feedback gain was required to obtain a perfectly performing control.

Because of the limitation of the supporting structure loads, up to only 400 lbs. were lifted. The actual design load of each arm is 750 lbs. At a load of 400 lbs., however, the dynamic response of the servo to operator inputs was well in excess of that required. Measured performance characteristic compared very closely to calculated values (i.e. compliance; calculated = 2.1%, measured = 1.7%), and the dynamic compliance characteristic of control was well within the limits of acceptability.

DOCUMENT CONTROL DATA - R & D

(Security classification of title, and of abstract and indexing annotation must be entered when the overall report is classified)

1. ORIGINATING ACTIVITY (Corporate author) Specialty Materials Handling Products Operation, Research and Development, General Electric Company Schenectady, New York 12305		2a. REPORT SECURITY CLASSIFICATION Unclassified	
3. REPORT TITLE Machine Augmentation of Human Strength and Endurance		2b. GROUP	
4. DESCRIPTIVE NOTES (Type of report and inclusive dates) Summary of Program progress through July 1, 1969			
5. AUTHOR(S) (First name, middle initial, last name) John B. Makinson Dale P. Bodine Bruce E. Fick			
6. REPORT DATE July 1, 1969	7a. TOTAL NO. OF PAGES 78	7b. NO. OF REFS	
8a. CONTRACT OR GRANT NO. Contract N00014-66-C0051 A. PROJECT NO. Contract Authorization Ident. No. NR 196-049 (Hardiman) Project No. IN624101050702		8b. ORIGINATOR'S REPORT NUMBER(S) S-69-1116	
9. OTHER REPORT NO(S) (Any other numbers that may be assigned this report)			
10. DISTRIBUTION STATEMENT This document has been approved for public release and sale; its distribution is unlimited.			
11. SUPPLEMENTARY NOTES		12. SPONSORING MILITARY ACTIVITY Office of Naval Research Naval Air Systems Command Army Mobility Equipment Research and Development Center	
13. ABSTRACT Summary of progress and achievements on the Hardiman I Prototype Project. This report covers program history through completion of the design phase. Following conceptual and human factors studies, a prototype of a powered exoskeletal harness has been designed. Individual joint assemblies have been simulated for testing. Portions of the actual prototype arm and leg systems have been built and tested. This device will amplify man's strength and endurance while retaining his versatility and dexterity. Advanced work in human factors, bilateral servo systems, mechanical and hydraulic design are key factors in this program.			

Unclassified
Security Classification

14 KEY WORDS	LINK A		LINK B		LINK C	
	ROLE	WT	ROLE	WT	ROLE	WT
Hardiman Exoskeleton Manipulator Bilateral Servos Joints-in-Series						

Unclassified
Security Classification